

Supports muraux
Muursteunen
Wandhalterungen
Soporte de pared

935402 SL21S / N°8
953121 SL21M / N°9

GUIDE D'UTILISATION	02
HANDLEIDING	10
GEBRAUCHSANLEITUNG	18
MANUEL DEL USUARIO.....	26

edenwood

Merci !

Merci d'avoir choisi ce produit EDENWOOD.
Choisis, testés et recommandés par
ELECTRO DEPOT. Les produits de la marque
EDENWOOD vous assurent une utilisation
simple, une performance fiable et une qualité
irréprochable.

Grâce à cet appareil, vous savez que chaque
utilisation vous apportera satisfaction.

Bienvenue chez ELECTRO DEPOT.

Visitez notre site Internet : www.electrodepot.fr



ELECTRO DEPOT

A

Avant d'installer le support

- 4 Consignes de sécurité
 - 6 Pièces fournies
 - 6 Outils nécessaires (non fournis)
-

B

Installation du support

- 7 Installation du support

Consignes de sécurité

La structure du mur doit être capable de supporter une charge d'au moins 25 kg pour les téléviseurs de 56 à 140 cm (modèle n°8), et de 30 kg pour les téléviseurs de 82 à 152 cm (modèle n°9). Dans le cas contraire, il faut renforcer le mur. Il est impératif de respecter une procédure d'installation correcte par un technicien qualifié, comme expliqué dans les instructions d'installation. Le non-respect de ces instructions peut entraîner des blessures graves voire mortelles.

Les consignes de sécurité doivent être suivies tout au long de l'installation de ce produit. Utilisez un équipement de sécurité et des outils adaptés pour l'installation, afin d'éviter tout risque de blessure.

Avant l'installation de ce produit, vous devez lire et comprendre parfaitement les instructions d'installation. Les instructions d'installation doivent être lues avec attention, afin d'éviter les risques de blessure et d'endommagement matériel. Conservez ces instructions d'installation dans un endroit facilement accessible, pour les consulter ultérieurement.

 Une structure solide doit soutenir le poids de l'écran. Si le montage s'effectue sur un mur qui comporte des montants en bois, le centre exact du montant doit être repéré avant l'installation.

 Ne pas installer sur une structure exposée aux vibrations, mouvements ou impacts. Le non-respect de ces règles peut entraîner l'endommagement de l'écran et/ou de la surface du support.

 Ne pas installer près d'un radiateur, d'une cheminée, dans la lumière directe du soleil, près d'une source de climatisation ou de chaleur directe. Le non-respect de cette règle peut entraîner l'endommagement de l'écran et augmenter le risque d'incendie.

 La procédure d'installation doit être mise en œuvre par au moins deux personnes qualifiées. Toute chute ou mauvaise manipulation de l'écran peut entraîner une blessure et/ou un endommagement.

 Surfaces recommandées pour le montage : montants en bois et béton lisse et solide. Si le support doit être installé sur une autre surface que le bois, utilisez du matériel approprié (disponible en magasin).

Pièces fournies

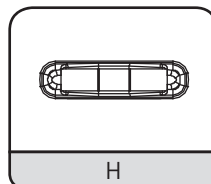
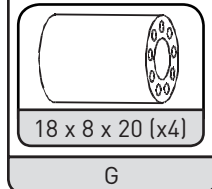
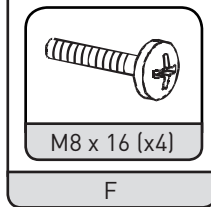
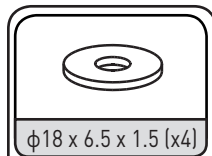
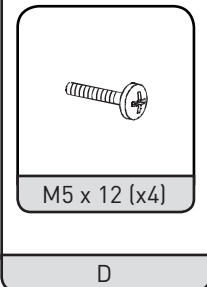
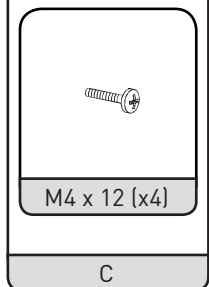
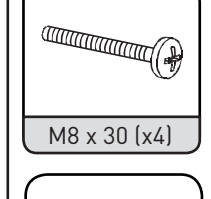
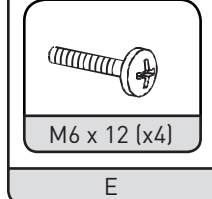
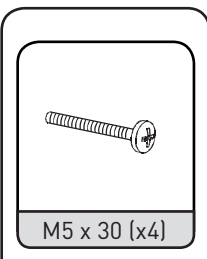
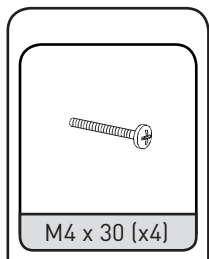
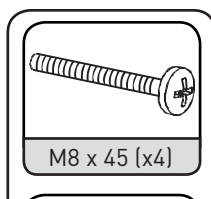
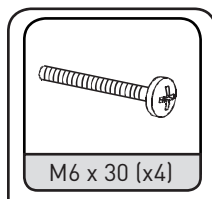
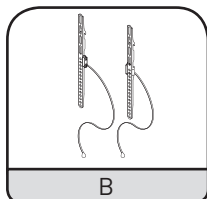
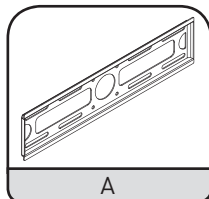

Outils nécessaires (non fournis)

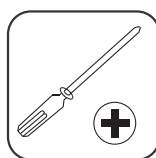
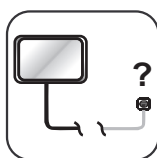

①

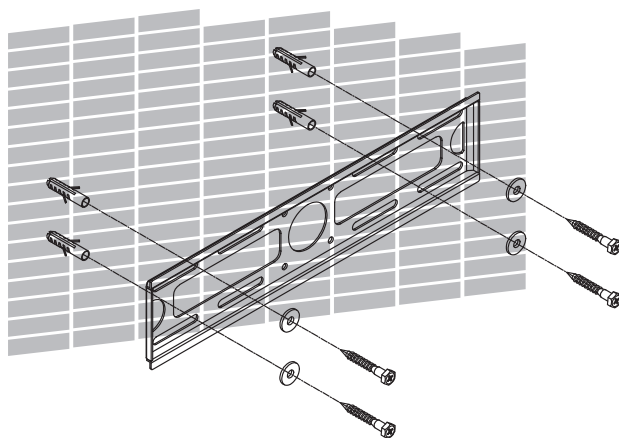
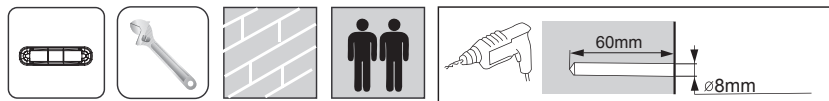
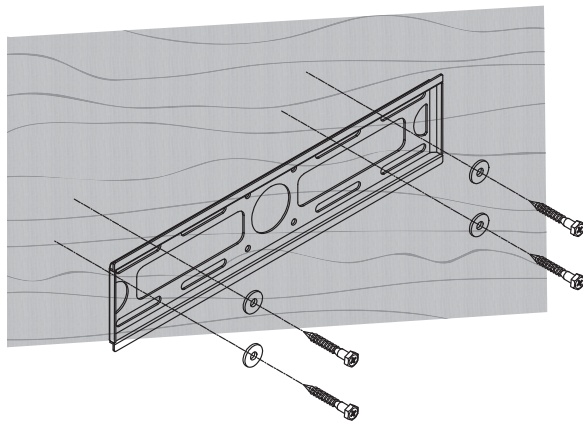

②

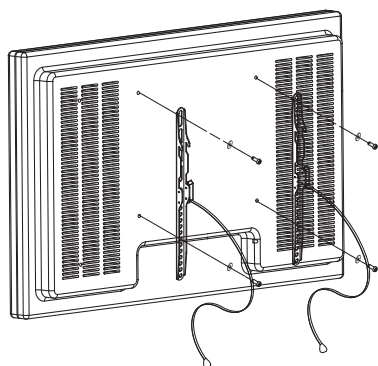
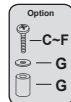

OU

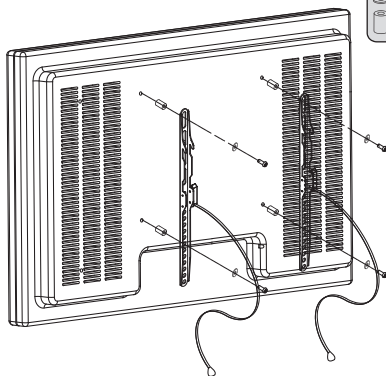

③

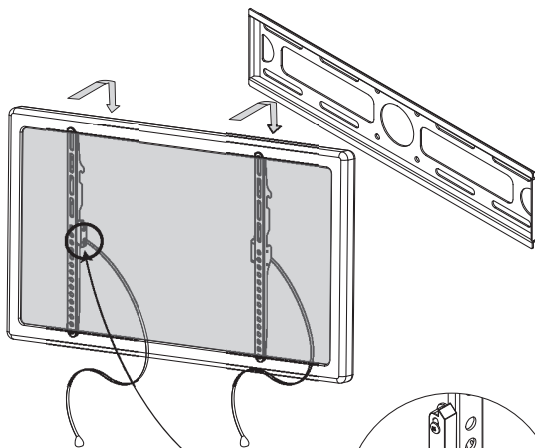

Tirer pour
verrouiller et/ou
déverrouiller

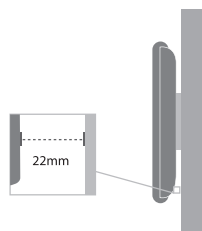
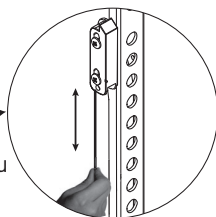

Bedankt!

Bedankt om voor dit product van EDENWOOD gekozen te hebben.

Gekozen, getest en aanbevolen door ELECTRO DEPOT. De producten van het merk EDENWOOD verzekeren u een eenvoudig gebruik, een betrouwbare prestatie en een onberispelijke kwaliteit. Dankzij dit toestel weet u dat elk gebruik tevredenstellend zal zijn.

Welkom bij ELECTRO DEPOT.

Bezoek onze website www.electrodepot.be



A

Alvorens de steun te monteren

- 12 Veiligheidsinstructies
 - 14 Geleverde onderdelen
 - 14 Noodzakelijk gereedschap (niet meegeleverd)
-

B

Installatie van de steun

- 15 Installatie van de steun

Veiligheidsinstructies

De structuur van de muur dient in staat te zijn om een last van ten minste 25 kg te dragen voor televisies van 56 tot 140 cm (model nr. 8) en van 30 kg voor de televisies van 82 tot 152 cm (model nr. 9). Indien dit niet het geval is, dient de muur versterkt te worden. De installatieprocedure dient verplicht gevolgd te worden door een erkend technicus, zoals uitgelegd in de installatie-instructies. Wanneer deze instructies niet nageleefd worden, kan dit leiden tot ernstige en zelfs dodelijke ongevallen.

De Veiligheidsinstructies dienen nageleefd te worden bij het installeren van dit product. Gebruik veiligheidsuitrusting en gereedschap dat aangepast is voor de installatie, om het risico op letsels te voorkomen.

Vóór de installatie van dit product, dient u de installatie-instructies te lezen en volledig te begrijpen. De installatie-instructies dienen aandachtig gelezen te worden, om het risico op letsels en materiaalschade te voorkomen. Bewaar deze installatie-instructies op een makkelijk toegankelijke plaats, om ze later te raadplegen.

 Een veilige structuur dient het gewicht van het scherm te dragen.

Indien de montage uitgevoerd wordt op een muur met houten stijlen, dient het exacte midden van deze stijl gezocht te worden vóór de montage.

 Niet installeren op een structuur die blootgesteld wordt aan trillingen, bewegingen of schokken. Wanneer deze regels niet nageleefd worden, kan dit leiden tot beschadiging van het scherm en/of het steunoppervlak.

 Niet installeren in de buurt van een radiator, schoorsteen, in direct zonlicht, in de buurt van een airco- of verwarmingstoestel. Wanneer deze regel niet nageleefd wordt, kan dit leiden tot beschadiging van het scherm en verhoogd dit het risico op brand.

 De installatieprocedure dient uitgevoerd te worden door ten minste twee bekwame personen. Elke val of verkeerde behandeling van het scherm kan leiden tot een letsel en/of schade.

 Oppervlakken die aangeraden worden voor de montage: houten stijlen en glad en stevig beton. Indien de steun geïnstalleerd moet worden op een oppervlak dat niet uit hout bestaat, gebruikt u het passende materiaal (verkrijgbaar in de winkel)

Geleverde onderdelen

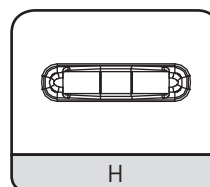
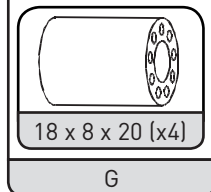
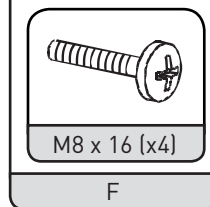
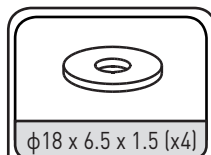
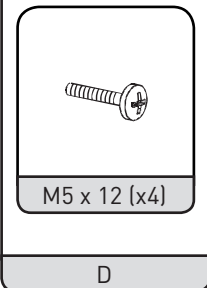
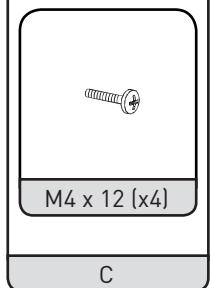
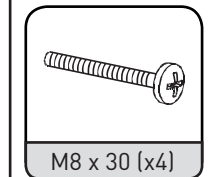
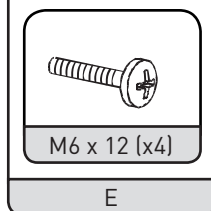
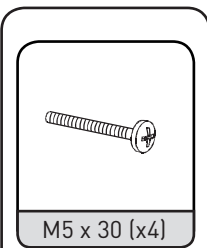
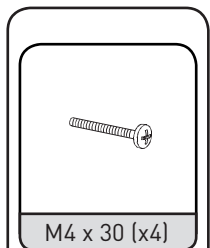
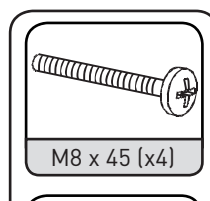
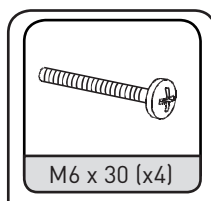
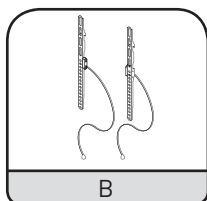
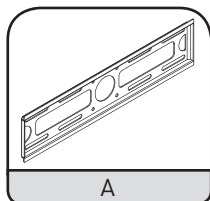

Outils nécessaires (non fournis)

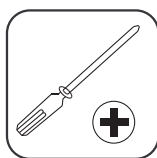
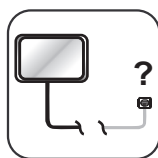

①

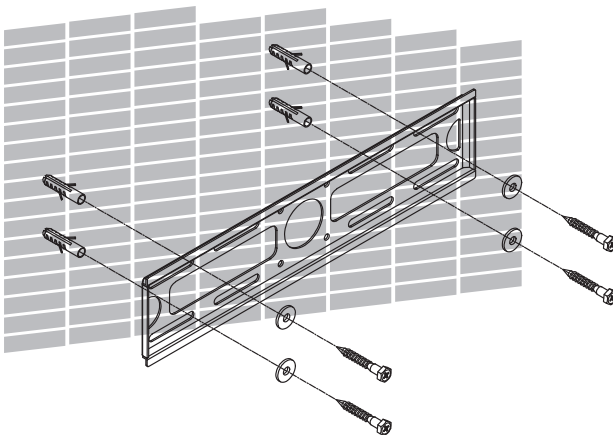
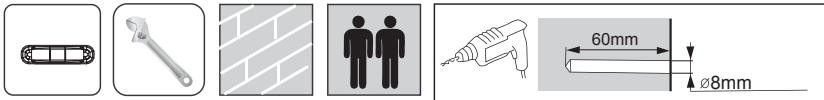
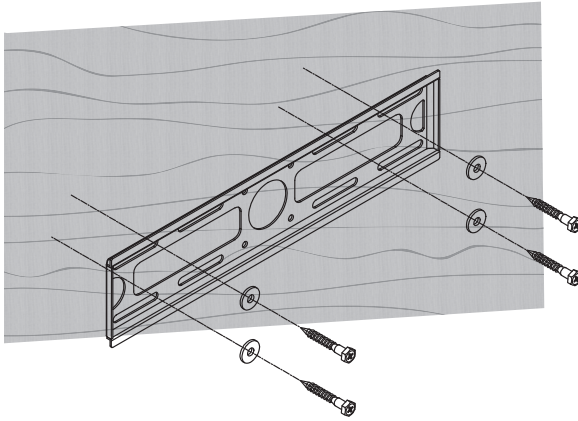

②

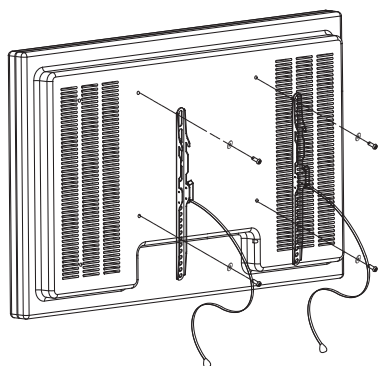
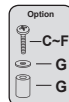

of

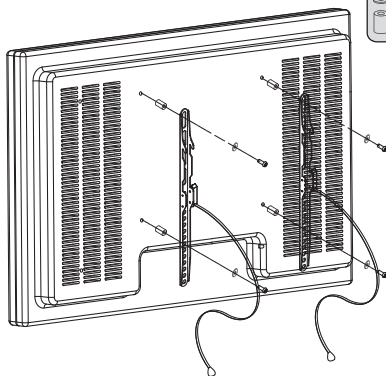

③

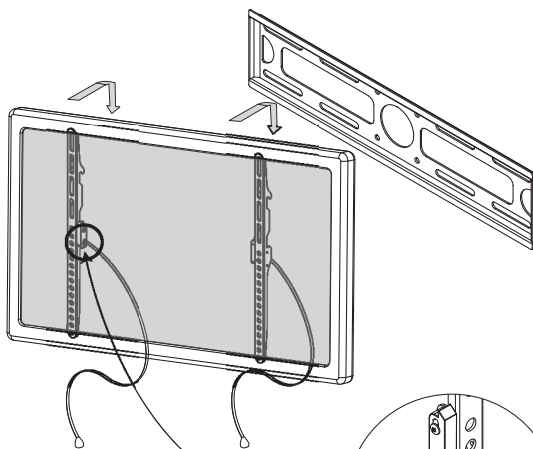

Trekken om te vergrendelen en/of te ontgrendelen

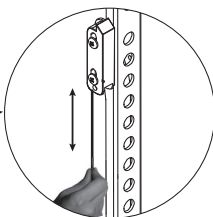

Vielen Dank!

Vielen Dank, dass Sie dieses EDENWOOD- Produkt gewählt haben.

Ausgewählt, getestet und empfohlen durch ELECTRO DEPOT. Die Produkte der Marke EDENWOOD garantieren Ihnen Benutzerfreundlichkeit, zuverlässige Leistung und tadellose Qualität. Mit diesem Gerät können Sie sicher sein, dass sie jeder Gebrauch zufriedenstellt.

Willkommen bei ELECTRO DEPOT.

Besuchen Sie unsere Webseite auf www.electrodepot.fr



ELECTRO DEPOT

A Vor der Installation der Halterung

- 20 Sicherheitsvorschriften
 - 22 Lieferumfang
 - 22 Nötige Werkzeuge (nicht mitgeliefert)
-

B Installation der Halterung

- 23 Installation der Halterung

Sicherheitsvorschriften:

Die Wandstruktur muss für Fernseher von 56 bis 140 cm (Modell Nr. 8) eine Last von mindestens 25 kg und für Fernseher von 82 bis 152 cm (Modell Nr. 9) eine Last von mindestens 30 kg tragen können. Anderenfalls muss die Wand verstärkt werden. Die Installation muss unbedingt korrekt und entsprechend der Installationsanleitung von einem qualifizierten Techniker ausgeführt werden. Das Nichtbefolgen dieser Anleitung kann zu schweren oder sogar tödlichen Verletzungen führen.

Die Sicherheitsvorschriften müssen während der ganzen Installation dieses Produkts befolgt werden. Verwenden Sie eine angemessene Sicherheitsausrüstung und die geeigneten Werkzeuge für die Installation, um jedes Verletzungsrisiko zu vermeiden.

Vor der Installation dieses Produkts müssen Sie die Installationsanleitung gelesen und gut verstanden haben. Lesen Sie die Installationsanleitung aufmerksam durch, um das Risiko einer Verletzung oder einer Sachbeschädigung zu vermeiden. Bewahren Sie diese Installationsanleitung an einem leicht zugänglichen Ort zur späteren Einsicht auf.

 Das Gewicht des Bildschirms muss von einer stabilen Struktur getragen werden.

Bei Montage der Halterung an einer Wand mit Holzstützen muss die genaue Mitte der betroffenen Stütze vor der Installation ermittelt werden.

 Nicht auf einer Struktur installieren, die Vibrationen, Bewegungen oder Stößen ausgesetzt ist. Das Nichtbefolgen dieser Vorschriften kann zur Beschädigung des Bildschirms und/oder der Oberfläche des Unterbaus führen.

 Nicht in der Nähe einer Heizung, eines Kamins, in direktem Sonnenlicht, in der Nähe einer Klimaanlage oder einer direkten Wärmequelle installieren. Das Nichtbefolgen dieser Vorschrift kann zur Beschädigung des Bildschirms führen und das Brandrisiko erhöhen.

 Die Installation ist von mindestens zwei qualifizierten Personen durchzuführen. Bei Herabfallen oder falscher Handhabung des Bildschirms kann Verletzungs- und/oder Beschädigungsgefahr bestehen.

 Empfohlene Montageflächen: Holzstützen und glatter, solider Beton. Wenn die Halterung nicht auf Holz montiert wird, verwenden Sie das geeignete Material (im Handel verfügbar).

Lieferumfang

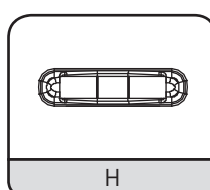
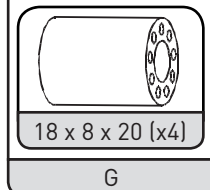
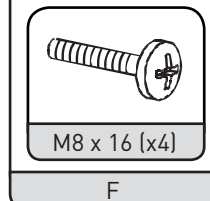
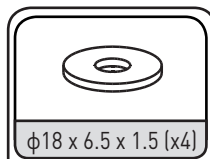
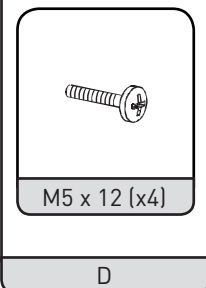
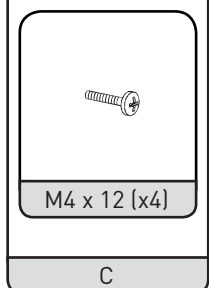
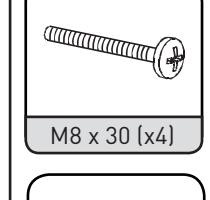
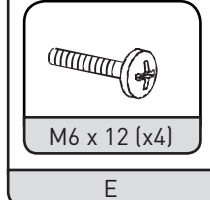
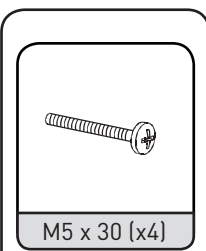
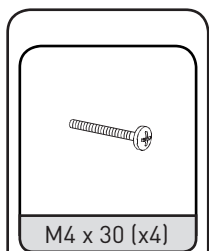
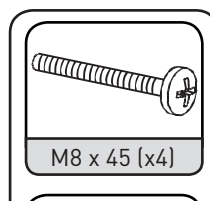
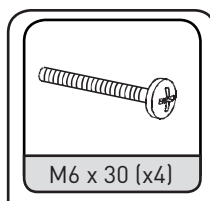
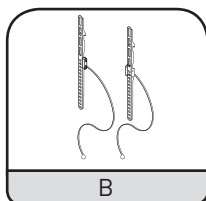
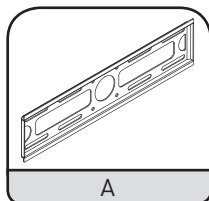

Outils nécessaires (non fournis)

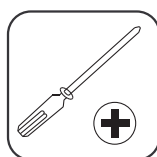
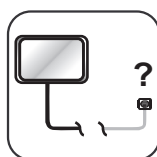

①

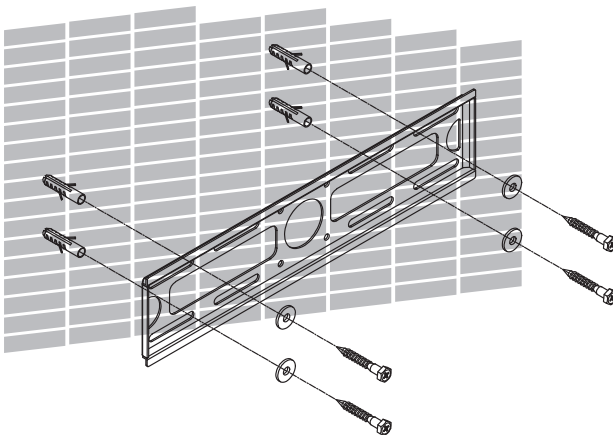
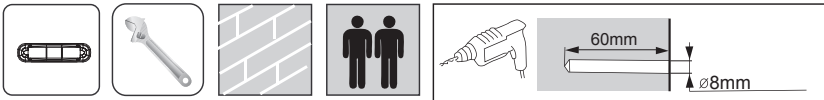
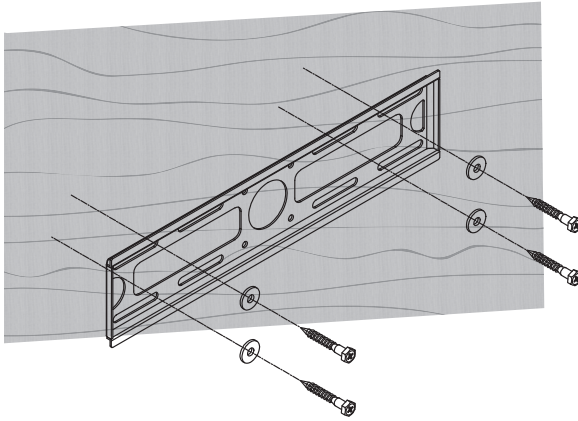

②

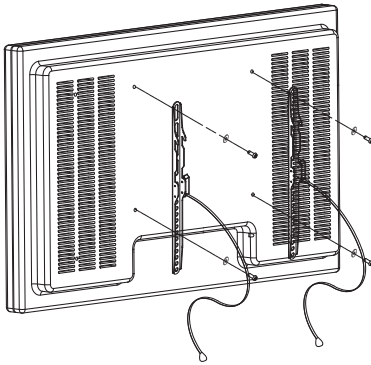
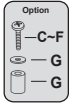
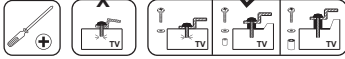

oder

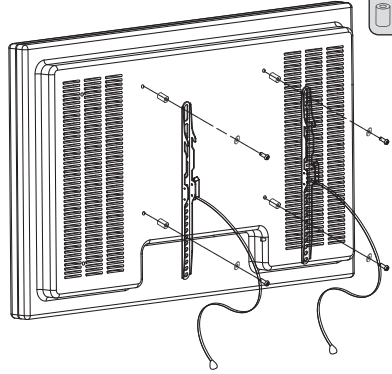

③

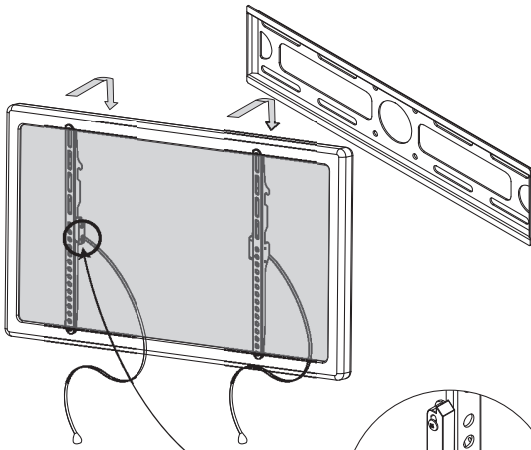

Ziehen zum
Verriegeln und/oder
Entriegeln

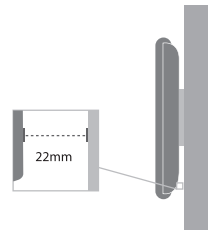
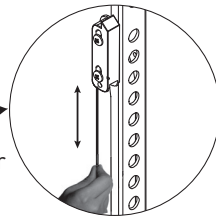

¡Gracias!

Gracias por haber elegido este producto EDENWOOD.

Elegidos, probados y recomendados por ELECTRO DEPOT. Los productos de la marca EDENWOOD le aseguran una utilización sencilla, un rendimiento fiable y una calidad impecable. Quedará muy satisfecho cada vez que use este aparato.

Le damos la bienvenida a ELECTRO DEPOT.

Visite nuestro sitio web: www.electrodepot.fr



A	Antes de instalar el soporte	28	Instrucciones de seguridad
		30	Piezas suministradas
		30	Herramientas necesarias (no incluidas)
<hr/>			
B	Instalación del soporte	31	Instalación del soporte

Instrucciones de seguridad

La estructura de la pared debe poder soportar una carga de, al menos, 25 kg para los televisores de 56 a 140 cm (modelo n.º 8), y de 30 kg para los televisores de 82 a 152 cm (modelo n.º 9). En caso contrario, habrá que reforzar el muro. Es obligatorio respetar un procedimiento de instalación correcto por un técnico cualificado, como se explica en las instrucciones de instalación. El incumplimiento de estas instrucciones puede provocar heridas graves e incluso mortales.

Se deben seguir todas las consigas de seguridad a lo largo de la instalación del producto. Utilice un equipo de seguridad y las herramientas adaptadas para su instalación para evitar cualquier riesgo de heridas.

Antes de la instalación del producto, debe leer y comprender perfectamente las instrucciones de instalación. Las instrucciones de instalación deben leerse con atención para evitar los riesgos de heridas y los daños del material. Conserve estas instrucciones en un lugar fácilmente accesible para poder consultarlas más adelante si fuese necesario.

 Una estructura segura debe sostener el peso de la pantalla.

Si el montaje se realiza sobre una pared que tiene montantes de madera, el centro exacto del montante debe identificarse antes de la instalación.

 No colocar sobre una estructura sometida a vibraciones, movimientos o impactos. El incumplimiento de estas reglas puede dañar la pantalla y/o la superficie del soporte.

 No colocar cerca de un radiador, una chimenea, ni expuesto directamente a la luz del sol, a una fuente de climatización o de calor. El incumplimiento de estas reglas puede dañar la pantalla y aumentar el riesgo de incendios.

 La instalación debe llevarse a cabo, al menos, por dos personas cualificadas. La caída o la manipulación incorrecta de la pantalla puede provocar heridas y/o daños.

 Superficies recomendadas para el montaje: montantes de madera y hormigón liso y resistente. Si el soporte debe instalarse en otro tipo de superficie que no sea madera, utilice el material apropiado (disponible en tienda).

Piezas suministradas

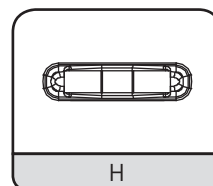
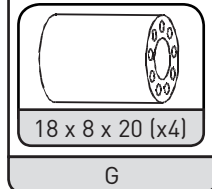
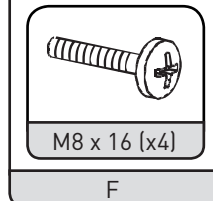
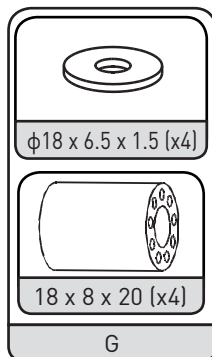
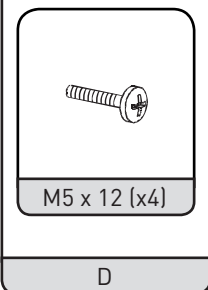
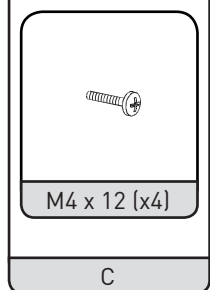
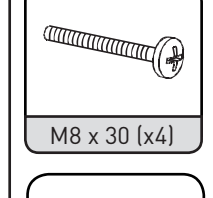
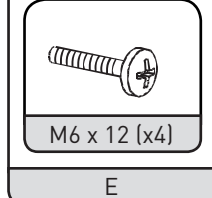
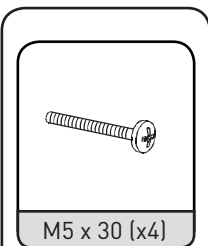
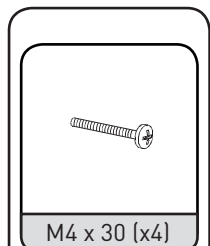
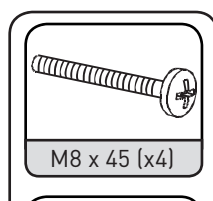
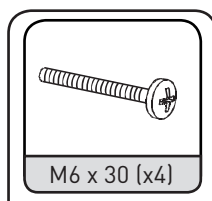
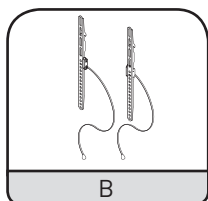
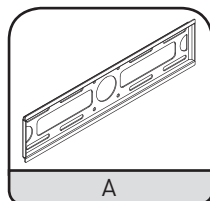

Outils nécessaires (non fournis)

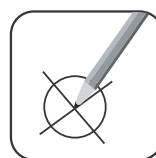
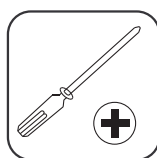
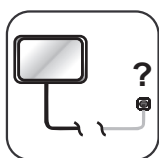

①

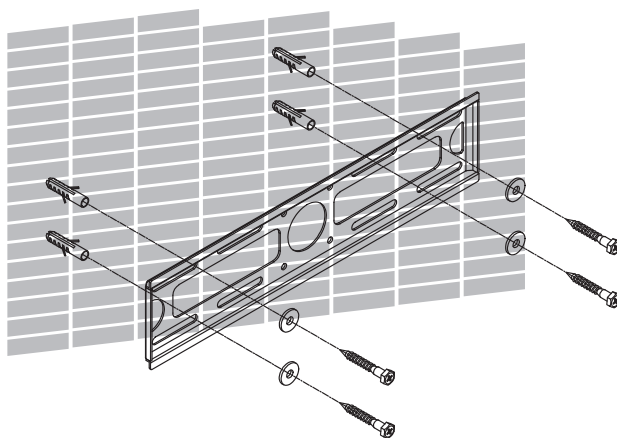
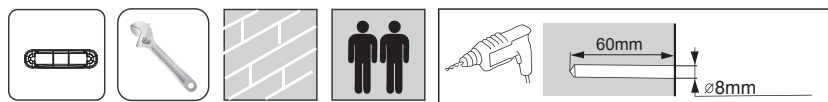
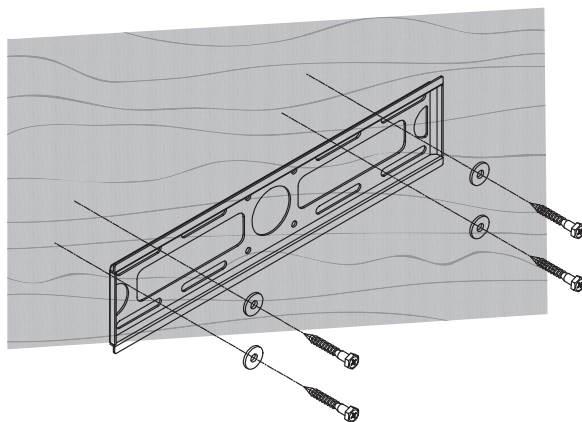

②

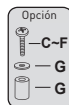
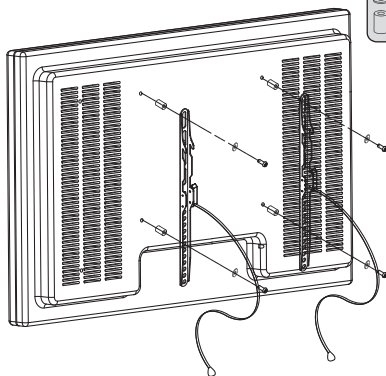
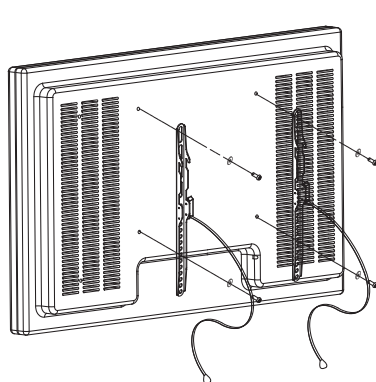

③

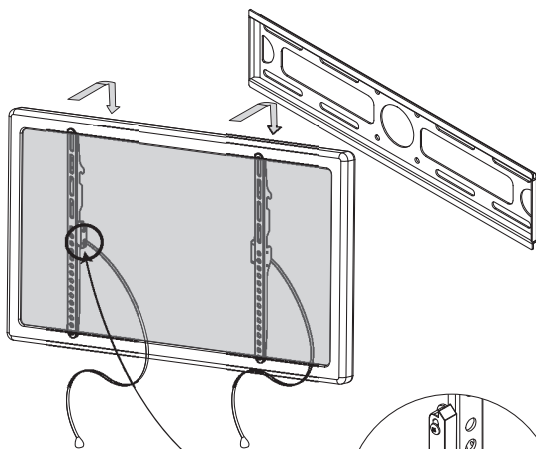

Tirar para
bloquear y/o
desbloquear

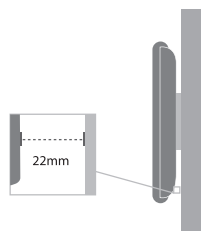
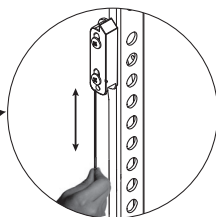

CONDITION DE GARANTIE

FR

Ce produit est garanti pour une période de 2 ans à partir de la date d'achat*, contre toute défaillance résultant d'un vice de fabrication ou de matériau. Cette garantie ne couvre pas les vices ou les dommages résultant d'une mauvaise installation, d'une utilisation incorrecte ou de l'usure anormale du produit.

*sur présentation du ticket de caisse.

GARANTIEVOORWAARDEN

NL

Dit product wordt gegarandeerd voor een periode van 2 jaar vanaf de aankoopdatum*, voor elke storing die het gevolg is van een fabricagefout of het materiaal. Gebreken of schade door slechte installatie, onjuist gebruik of abnormale slijtage van het product worden niet gedekt door deze garantie.

*op vertoon van kassabon.

GARANTIEBEDINGUNGEN

DE

Für dieses Produkt wird ab dem Verkaufsdatum* eine Garantie von 2 Jahren für Mängel infolge von Herstellungs- oder Materialfehlern gewährt. Von dieser Garantie ausgeschlossen sind Mängel oder Schäden, die durch falsche Installation, Handhabungsfehler oder unsachgemäßen Gebrauch verursacht werden.

*gegen Vorlage des Kassenbelegs.

CONDICIONES DE GARANTÍA

ES

Este producto tiene una garantía por un período de 2 años a partir de la fecha de compra*, ante cualquier fallo resultante de un defecto de fabricación o de material. Esta garantía no cubre los defectos o los daños provocados por una mala instalación, un uso inadecuado o por un desgaste anormal del producto.

*mediante la presentación del tique de compra

Importé par / Geïmporteerd door / Importiert durch / Importado por

ELECTRO DEPOT

1 route de Vendeville

59155 FACHES-THUMESNIL

www.electrodepot.fr



La mise sur le marché de ce produit est opérée par ELECTRO DEPOT qui s'assure de la conformité du produit aux exigences applicables.

Het op de markt brengen van dit product wordt behandeld door ELECTRO DEPOT, dat de conformiteit van het product met de geldende regels verzekert.

Dieses Produkt wird von der Gesellschaft ELECTRO DEPOT auf den Markt gebracht, welche die Übereinstimmung des Produkts mit den geltenden Anforderungen garantiert.

La comercialización de este producto se lleva a cabo por ELECTRO DEPOT que comprueba la conformidad del producto respecto a las exigencias aplicables.

Made in PRC