

EN	<p>WARRANTY CONDITIONS This product is guaranteed for a period of 2 years from the date of purchase* against any failure resulting from a manufacturing or material defect. This warranty does not cover defects or damage resulting from incorrect installation, improper use or abnormal wear of the product. *as shown on the sales receipt.</p>
FR	<p>CONDITION DE GARANTIE Ce produit est garanti pour une période de 2 ans à partir de la date d'achat*, contre toute défaillance résultant d'un vice de fabrication ou de matériau. Cette garantie ne couvre pas les vices ou les dommages résultant d'une mauvaise installation, d'une utilisation incorrecte ou de l'usure anormale du produit. *sur présentation du ticket de caisse.</p>
NL	<p>GARANTIEVOORWAARDEN Dit product wordt gegarandeerd voor een periode van 2 jaar vanaf de aankoopdatum*, voor elke storing die het gevolg is van een fabricagefout of het materiaal. Gebreken of schade door slechte installatie, onjuist gebruik of abnormale slijtage van het product worden niet gedekt door deze garantie. *op vertoon van kassabon.</p>
ES	<p>CONDICIONES DE GARANTÍA El certificado de garantía de este producto tiene una duración de 2 años a partir de la fecha de compra* que se limita a los defectos de fabricación y averías del material. Se excluyen de la garantía deficiencias o daños originados por una mala instalación, errores en la manipulación o por un uso inadecuado. *previa presentación del comprobante de compra.</p>
IT	<p>CONDIZIONI DI GARANZIA Il prodotto è garantito per un periodo di 2 anni a partire dalla data di acquisto*, contro i difetti di fabbricazione e dei materiali. La garanzia non copre i difetti o i danni derivanti da un'installazione impropria, da un uso scorretto o da usura anormale del prodotto. *su presentazione dello scontrino d'acquisto.</p>

ELECTRO DEPOT
1 route de Vendeville
59155 FACHES-THUMESNIL - FRANCE

Washing machine
Lave-linge
Wasmachine
Lavadora
Lavatrice

971310 - WF 814 S566C
971326 - WF 714 B W566C
971351 - WF 1214 B W566C
971683 - WF 714 B B566C
971684 - WF 714 B S566C
972324 - WF 814 B X566C

INSTRUCTIONS FOR USE02
CONSIGNES D'UTILISATION36
GEbruikSAANWIJZINGEN70
INSTRUCCIONES DE USO104
ISTRUZIONI PER L'USO140

VALBERG

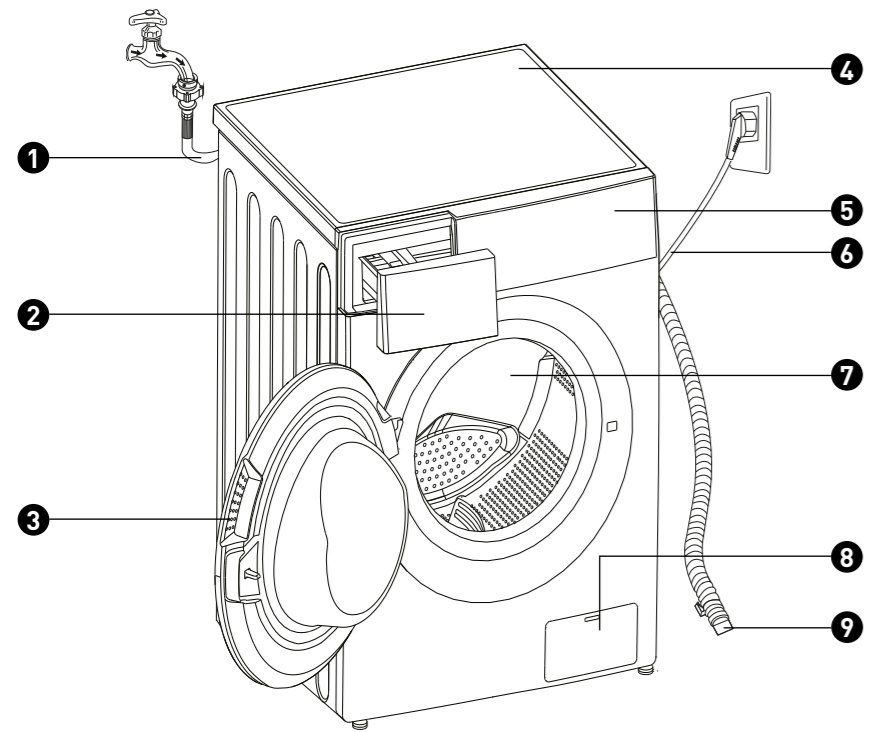

10

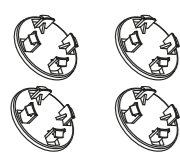

11

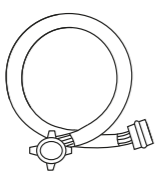

Thanks!

Thank you for choosing this VALBERG product. Chosen, tested and recommended by ELECTRO DEPOT, products from the VALBERG brand are easy to use, reliable and of an impeccable standard. Thanks to this appliance, you can be sure that each use will bring you satisfaction.

Welcome to ELECTRO DEPOT.

Visit our website: www.electrodepot.fr

Table of contents

A

**Preview of the
appliance**

Description of the appliance

B

Using the appliance

Installation
Operation

C

Useful information

Cleaning and Care
Trouble shooting
Customer services

Description of the appliance

- ❶ Water supply hose
- ❷ Detergent dispenser
- ❸ Door
- ❹ Top cover
- ❺ Control panel
- ❻ Power supply cord
- ❼ Drum
- ❽ Service flap
- ❾ Drain hose
- ❿ 4 x Cover caps
- ⓫ 1 x Supply hosecold water

NOTE

The product picture is for illustration only; please refer to the real product as reference.

Installation

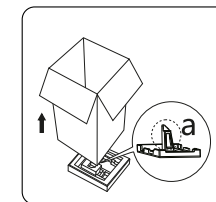
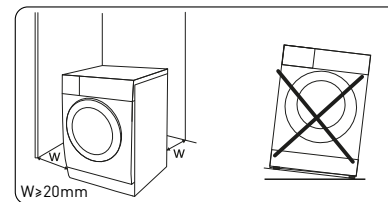

Installation area

WARNING!

- Stability is important to prevent the product from wandering! Make sure the machine is level and stable.
- Make sure that the product does not stand onto the powercord.
- Be sure to maintain the minimum distances from walls as shown in the picture

Before installing the machine, the following type of location should be selected:

- ❶ Rigid, dry, and level surface
- ❷ Avoid direct sunlight
- ❸ Sufficient ventilation
- ❹ Room temperature is above 0°C
- ❺ Keep far away from heat sources such as coal- or gas-burning appliances.

Unpacking the washing machine

WARNING!

- Packaging material (e.g. Films, Styrofoam) can be dangerous for children.
- There is a risk of suffocation! Keep all packaging well away from children.

- 1 Remove the cardboard box and styrofoam packing.
- 2 Lift the washing machine and remove the base packaging. Make sure the small foam triangle is removed together with the bottom packaging. If not, lay the unit down on its side and remove it manually.
- 3 Remove the tape securing the power supply cord and drain hose.
- 4 Remove the inlet hose from the drum.

Remove the transport bolts

WARNING!

You must remove the transport bolts from the back side before using the product.



- 1 Loosen the 4 transport bolts with a spanner.
- 2 Remove the bolts including the rubber parts and keep them for future use.
- 3 Close the holes using the cover caps.

Levelling the washing machine

WARNING!

The lock nuts on all four feet must be screwed tightly against the housing.



- 1 Loosen the lock nut.
- 2 Turn the foot until it reaches the floor.
- 3 Adjust the legs and lock the nuts with a spanner. Make sure the machine is level and steady.

Connect the water supply hose

WARNING!

To prevent leakage or water damage, follow the instructions in this chapter

- Do not kink, crush or modify the water inlet hose.



Connect the water supply hose to the water inlet valve and a water tap with cold water as indicated.

NOTE

Connect manually, do not use tools. Check if the connections are tight.

Drain Hose

WARNING!

- Do not kink or stretch the drain hose.
- Position the drain hose properly, otherwise damage might result or water leakage.

There are two ways to place the end of the drain hose:

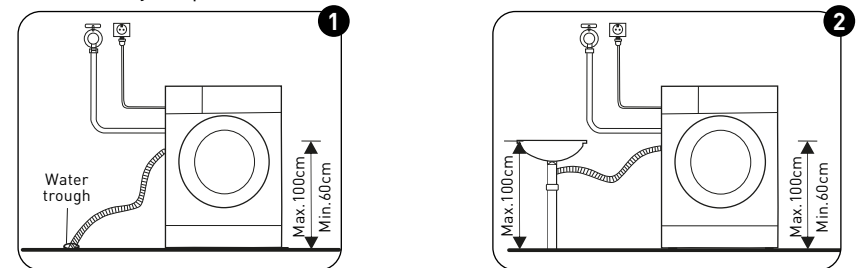

- 1 Put it into the water trough.
- 2 Connect it to the branch drain pipe of the trough.

Operation

Quick Start

CAUTION!

- Before washing, please make sure the washing machine is installed properly.
- Your appliance was thoroughly checked before it left the factory. To remove any residual water and neutralise potential odours, it's recommended that you clean your appliance before first use. For this reason, start the Cotton programme at 90°C without laundry or detergent.

CALIBRATION

It's recommended that you calibrate the washing machine to provide the best performance. The appliance can detect the amount of laundry loaded. This function optimises product performance by minimising energy and water consumption, saving you money and time. For this reason, it's recommended that you calibrate the appliance for best use.

- 1 Remove all accessories from the drum and close the door;
- 2 Insert the mains plug in the socket;
- 3 Switch on the washing machine and press "Delay" and "Temp." simultaneously for 10 seconds until "t19" is displayed;
- 4 Press [▶||] to start the appliance and wait until "****" is displayed.

1 Before Washing

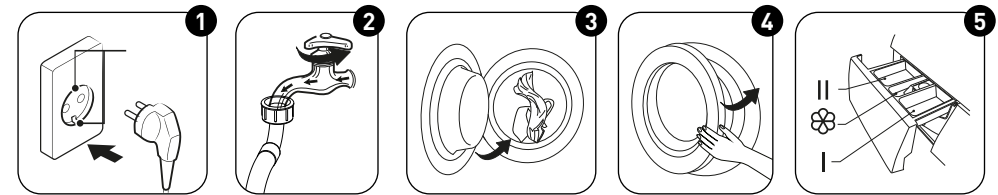

- 1 Plug in
- 2 Open tap
- 3 Load
- 4 Close door
- 5 Add detergent

NOTE

Detergent needs to be added in compartment I if the pre-wash function is selected.

2 Washing

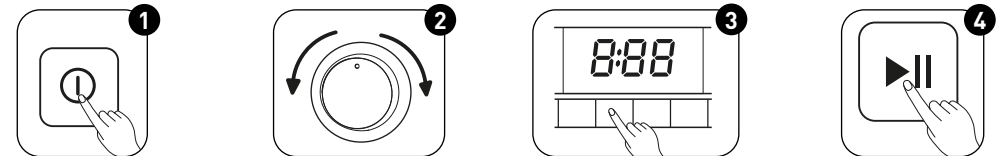

- 1 Power On
- 2 Select programme
- 3 Select function or retain default settings
- 4 Press Start/Pause to start the programme

3 After Washing

Buzzer beep and "End" on display.

Before Each Wash

- The ambient temperature of the washing machine should be 5-40°C. If used under 0°C, the inlet valve and draining system may be damaged. If the machine is installed under freezing conditions, it should be transferred to normal ambient temperature to ensure the water supply hose and drain hose can unfreeze before use.
- Please check your laundry care labels and the detergent use instructions before washing. Use non-foaming or less-foaming detergent suitable for machine washing properly.

WARNING!

- Do not wash or dry articles that have been cleaned in, washed in, soaked in, or dabbed with combustible or explosive substances like wax, oil, paint, petrol, alcohol, kerosene, and other flammable materials.
- Washing single clothing items may create considerable eccentricity and cause the alarm to sound due to unbalance. Therefore, it is best to add one or two more laundry items to the wash so that the spin can be completed smoothly.

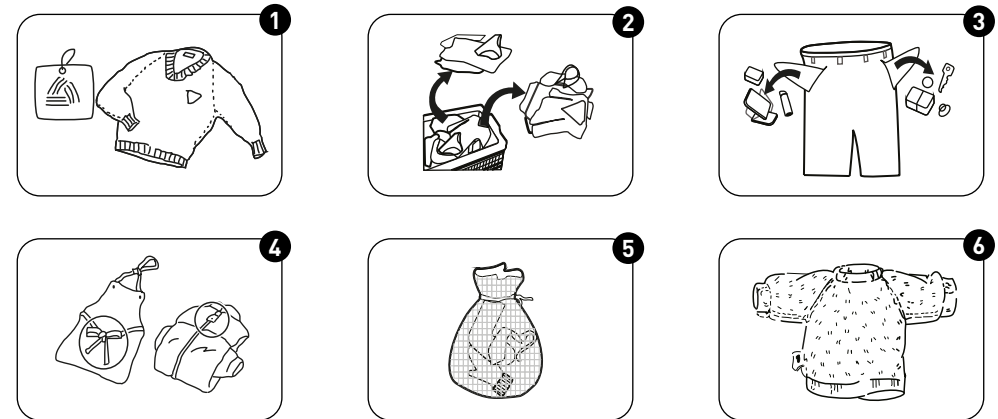



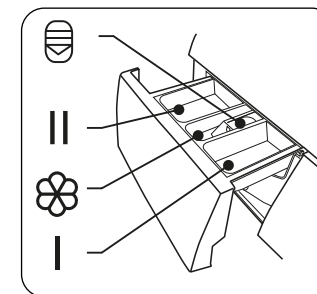













- 1 Check the care label
- 2 Sort laundry according to colour and textile type
- 3 Take all items out of pockets
- 4 Tie together long textile strips and belts, close zips and buttons
- 5 Put small items into a laundry bag
- 6 Turn easy-pilling and long-pile fabric inside out

Detergent Dispenser

- I Pre-wash
- II Main wash
- ☼ Softener
- ⊞ Release button to pull out the dispenser

CAUTION!

Detergent only needs to be added to "compartment I" after selecting the pre-wash function.

Programme	I	II	
 Synthetic	<input type="radio"/>	<input checked="" type="radio"/>	<input type="radio"/>
 Mix	<input type="radio"/>	<input checked="" type="radio"/>	<input type="radio"/>
 Rapid 45'	<input type="radio"/>	<input checked="" type="radio"/>	<input type="radio"/>
 Quick 15'		<input checked="" type="radio"/>	<input type="radio"/>
 Wool		<input checked="" type="radio"/>	<input type="radio"/>
 Allergy Care	<input type="radio"/>	<input checked="" type="radio"/>	<input type="radio"/>
 Steam Care	<input type="radio"/>	<input checked="" type="radio"/>	<input type="radio"/>
 Rinse & Spin			<input type="radio"/>
 Spin Only			
 Sportswear	<input type="radio"/>	<input checked="" type="radio"/>	<input type="radio"/>
 20°C		<input checked="" type="radio"/>	<input type="radio"/>
 Jeans	<input type="radio"/>	<input checked="" type="radio"/>	<input type="radio"/>
 ECO 40-60°C		<input checked="" type="radio"/>	<input type="radio"/>
 Intensive		<input checked="" type="radio"/>	<input type="radio"/>
 Cotton	<input type="radio"/>	<input checked="" type="radio"/>	<input type="radio"/>

● Means must

○ Means optional

Detergent Recommendation

Recommended washing detergent	Wash cycles	Washing temp.	Type of laundry and textile
Heavy-duty detergent with bleaching agents and optical brighteners	Cotton, ECO 40-60, Mix, Jeans, Intensive	20 / 30 / 40 / 60	White laundry made from boil-proof cotton or linen
Colour detergent without bleaching agent and optical brighteners	Cotton, ECO 40-60, Mix, Jeans, Intensive	Cold/20/30/40	Coloured laundry made from cotton or linen
Colour or mild detergent without optical brighteners	Synthetic	Cold/20/30/40	Coloured laundry made from easy care fibres or synthetic materials
Mild washing detergent	Synthetic	20 / 30	Delicate textiles, silk, viscose
Special wool detergent	Wool	20 / 30	Wool

NOTE

- Agglomerating or poor-quality detergent or additive can be diluted in some water before pouring it into the detergent dispenser, to avoid its inlet getting blocked and thus causing a water overflow.
- Please choose a suitable type of detergent to obtain maximum washing performance and minimum water and energy consumption
- To achieve the best cleaning result, proper detergent dosing is important.
- Use a reduced amount of detergent if the drum is not filled completely.
- Always adjust the amount of detergent to suit the water hardness. If your tap water is soft, use less detergent.
- Dose according to how dirty your laundry is - less dirty clothes require less detergent.
- Highly concentrated (compact) detergent requires particularly accurate dosing.

The following symptoms are a sign of detergent overdosing:

- heavy foam formation
- poor washing and rinsing results

The following symptoms are a sign of detergent underdosing:

- laundry turns grey
- build-up of limescale deposits on the drum, the heating element and/or the laundry

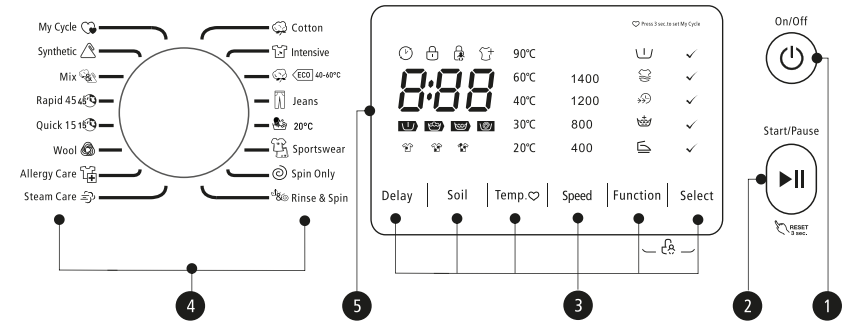
Control Panel**1 On/Off**

Turn the appliance on and off.

2 Start/Pause

Start or pause your programme.

3 Option

This allows you to select additional functions and will light up when selected.

4 Programmes

Available according to the laundry type.

5 Display

The display shows settings, estimated remaining time, options and status messages.

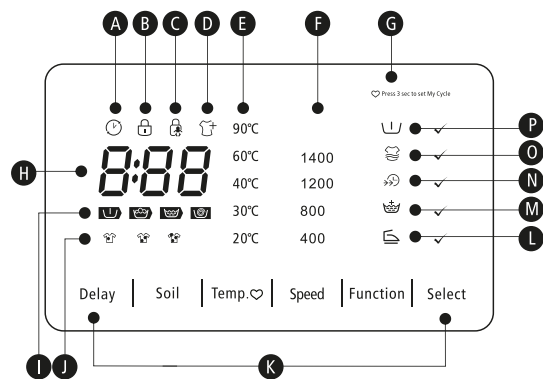
**A** Delay**B** Door Lock**C** Child Lock**D** Reload**E** Temp.**F** Speed**G** My Cycle

H	Wash Time	Delay Time	Error	End
	1:25	2h	E20	End







I Prewash-Wash-Rinse-Spin**J** Soil Level**K** Option**L** Anti-crease**M** Extra Rinse**N** Speed Wash**O** Extra Wash**P** Pre-Wash

Programmes

Programme	Load (kg)			Display Time
MACHINE CAPACITY >	7.0	8.0	12.0	7.0/8.0/12.0
Cotton	7.0	8.0	12.0	3:39
Intensive	7.0	8.0	12.0	3:48
ECO 40-60°C	7.0	8.0	12.0	3:13/3:32/3:56
Jeans	7.0	8.0	12.0	1:35
20°C	3.5	4.0	6.0	1:01
Sportswear	3.5	4.0	6.0	0:45
Spin Only	7.0	8.0	12.0	0:12
Rinse&Spin	7.0	8.0	12.0	0:20
Steam Care	7.0	8.0	12.0	1:47
Allergy Care	3.5	4.0	6.0	2:09
Wool	2.0	2.0	2.0	1:07
Quick 15'	2.0	2.0	2.0	0:15
Rapid 45'	2.0	2.0	2.0	0:45
Mix	7.0	8.0	6.0	1:20
Synthetic	3.5	4.0	6.0	3:17







- The above data is for reference only, and may change due to different actual use conditions.
- The values given for programmes other than the ECO 40-60 programme are indicative only.
- Concerning to Regulation(EU) No 1061/2010,
The EU energy efficiency class is: Energy test programme: Intensive 60/40°C; Speed: The highest speed;
Other as the default.
Half load for 7.0/8.0/12.0Kg machine: 3.5/4.0/6.0Kg.
- Concerning to Regulation(EU) 2019/2023,
The EU energy efficiency class is: Energy test programme: ECO 40-60. Other as the default.
Half load for 7.0/8.0/12.0Kg machine: 3.5/4.0/6.0Kg.
Quarter load for 7.0/8.0/12.0Kg machine: 2.0/2.0/3.0Kg.

Programmes

Cycle	Nominal capacity in kg	Cycle duration in hours and minutes	Energy consumption in kWh/operating cycle	Water consumption in litre/operating cycle	Highest temperature °C	Residual moisture in % / spin speed
 20°C	3.5	1:01	0.100	45	20	65% / 1000
 Cotton (60°C)	7.0	3:44	1.392	65	60	53% / 1400
 Intensive	7.0	3:48	1.000	68	40	70% / 800
 Mix	7.0	1:20	0.710	60	40	70% / 800
 Quick 15'	2.0	0:15	0.030	40	Cold	75% / 800
 ECO 40-60°C	7.0	-	0.775	54	36	53% / 1400
	3.5	-	0.47	44	34	53% / 1400
	2.0	-	0.2	35	21	53% / 1400







- The above data is for reference only, and may change due to different actual use conditions.
- The values given for programmes other than the ECO 40-60 programme are indicative only.
- Concerning to Regulation(EU) No 1061/2010,
The EU energy efficiency class is: Energy test programme: Intensive 60/40°C; Speed: The highest speed;
Other as the default.
Half load for 7.0Kg machine: 3.5Kg.
- Concerning to Regulation(EU) 2019/2023,
The EU energy efficiency class is: Energy test programme: ECO 40-60. Other as the default.
Half load for 7.0Kg machine: 3.5Kg.
Quarter load for 7.0Kg machine: 2.0Kg.

Programmes

Cycle 8kg	Nominal capacity in kg	Cycle duration in hours and minutes	Energy consumption in kWh/operating cycle	Water consumption in litre/operating cycle	Highest temperature °C	Residual moisture in % / spin speed
 20°C	4.0	1:01	0.15	50	20	65% / 1000
 Cotton (60°C)	8.0	3:44	1.498	70	60	53% / 1400
 Intensive	8.0	3:48	1.100	70	40	70% / 800
 Mix	8.0	1:20	0.75	65	40	70% / 800
 Quick 15'	2.0	0:15	0.030	40	Cold	75% / 800
  40-60°C	8.0	-	0.857	59	34	53% / 1400
	4.0	-	0.504	46	29	53% / 1400
	2.0	-	0.24	37	21	53% / 1400

- The above data is for reference only, and may change due to different actual use conditions.
- The values given for programmes other than the ECO 40-60 programme are indicative only.
- Concerning to Regulation(EU) No 1061/2010,
The EU energy efficiency class is: Energy test programme: Intensive 60/40°C; Speed: The highest speed;
Other as the default.
Half load for 8.0Kg machine: 4.0Kg.
- Concerning to Regulation(EU) 2019/2023,
The EU energy efficiency class is: Energy test programme: ECO 40-60. Other as the default.
Half load for 8.0Kg machine: 4.0Kg.
Quarter load for 8.0Kg machine: 2.0Kg.

Programmes

Cycle 12kg	Nominal capacity in kg	Cycle duration in hours and minutes	Energy consumption in kWh/operating cycle	Water consumption in litre/operating cycle	Highest temperature °C	Residual moisture in % / spin speed
 20°C	6.0	1:01	0.206	58	20	65% / 1000
 Cotton (60°C)	12.0	3:44	1.919	99	60	53% / 1400
 Intensive	12.0	3:48	1.417	99	40	70% / 800
 Mix	12.0	1:20	0.988	99	40	70% / 800
 Quick 15'	2.0	0:15	0.030	40	15	75% / 800
  40-60°C	12.0	-	1.345	87	40	53% / 1400
	6.0	-	0.858	62	38	53% / 1400
	3.0	-	0.242	42	20	53% / 1400

- The above data is for reference only, and may change due to different actual use conditions.
- The values given for programmes other than the ECO 40-60 programme are indicative only.
- Concerning to Regulation(EU) 2019/2023,
The EU energy efficiency class is: Energy test programme: ECO 40-60. Other as the default.
Half load for 12.0Kg machine: 6.0Kg.
Quarter load for 12.0Kg machine: 3.0Kg.

- ❶ The highest temperature reached by the laundry in the wash cycle for at least 5 minutes.
- ❷ Residual moisture after the wash cycle in water content percent and the spin speed at which this was achieved.
- ❸ The ECO 40-60 programme can clean normally soiled cotton laundry declared to be washable at 40°C or 60°C, together in the same cycle. This programme is used to assess compliance with regulation (EU) 2019/2023.

The most efficient programmes in terms of energy consumption are generally those that perform at lower temperatures and longer duration.

Loading the household washing machine up to the capacity indicated for the respective programmes will contribute to energy and water savings.

Noise and remaining moisture content are influenced by the spin speed: the higher the spin speed in the spinning phase, the higher the noise and the lower the remaining moisture content.

CAUTION!

If there is a break in the power supply while the machine is operating, a special memory stores the selected programme. The machine will continue the programme when the power supply is re-established.

Programmes

Programmes are available according to the laundry type.

Programmes



Synthetic

Wash synthetic items, for example: shirts, coats, bedding. While washing knitted textiles, detergent quantity should be reduced due to its loose string construction and easily forming bubbles. Hard-wearing textiles, heat-resistant textiles made of cotton or linen.



Mix

Mixed load consisting of textiles made of cotton and synthetics.



Rapid 45'

This programme is suitable for washing not very dirty clothes, saving energy and washing time



Quick 15'

Extra-short programme approx, suitable for lightly soiled washing as well as small amounts of laundry.



Wool

Hand- or machine-washable wool or richwool textiles. Especially gentle wash programme to prevent shrinkage, longer programme pauses (textiles rest in wash liquor).



Allergy Care

Washing machine can effectively kill some allergens and achieve anti-allergic effect by adapting 60°C high temperature for sterilisation.



Steam Care

Steam Care is applicable for daily laundries like cotton and synthetics. The steam can deeply penetrate the fibre, which effectively eliminates bacteria and germs, preventing odours and protecting your health.



Rinse & Spin

Extra rinse with spin.



Spin Only

Extra spin with selectable spin speed.



Sportswear

Washing activewear.



20°C

20°C default, can choose cold water.



Jeans

Specially for jeans.



ECO 40-60°C

Default 40°C, not selectable, suitable for laundry washing at about 40-60°C.



Intensive







































































To increase the washing effects, washing time is increased.



Cotton

Hard-wearing textiles, heat-resistant textiles made of cotton or linen.

Option

Cycle	Default Temp. (°C)	Default spin speed in rpm	Additional functions
Wash cycles		1400	
 Synthetic	40	1200	     
 Mix	40	800	     
 Rapid 45'	40	800	   
 Quick 15'	Cold	800	
 Wool	40	800	  
 Allergy Care	60	800	    
 Steam Care	40	800	     
 Rinse & Spin	-	800	  
 Spin Only	-	800	 
 Sportswear	20	800	   
 20°C	20	800	  
 Jeans	30	800	   
 ECO 40-60°C	-	1400	
 Intensive	40	800	
 Cotton	40	1400	     

NOTE

- For the maximum spin speed, programme time, and other details of the ECO 40-60 programme, please refer to the content on the Product Sheet page.
- The table shows which cycle offers which options for adjustment.

Temp.

Temp.

When needed, the washing temperature can be adjusted by pressing the temperature button in the following steps: Cold - 20°C - 30°C - 40°C - 60°C - 90°C.

Delay

Delay

Set the Delay function:

- ❶ Select a programme;
- ❷ Press the Delay button to choose the time (the delaying time is 0-24 hr.);
- ❸ Press [Start/Pause] to commence the delay operation



Cancel the Delay function:

Press the [Delay] button until the display be 0H. It should be pressed before starting the programme. If the programme has already started, you should switch off the programme to reset a new one.

Soil

Soil

The washing time will increase or decrease after you select it.

Pre Wash

Pre Wash

The Prewash function can get an extra wash before main wash, it is suitable for washing the dust rises to surface of the clothes; You need to put detergent into the Case (I) when select it.

Extra Wash

Extra Wash

Use for very dirty clothes. Select it to increase the washing time and intensity for increased washing effect.

Speed Wash

Speed Wash

This function can reduce the washing time.

**Extra Rinse**

The laundry will undergo an extra rinse when you select it.

**My Cycle**

To memorise the most frequently used programme.

After choosing the programme and setting the options, press [Temp.] 3 sec. before start to wash. The default setting course is Cotton.

**Anti-Crease**

Anti-Crease function can be used to reduce wrinkles in clothes.

**Reload**

This operation can be executed during the washing process. When the drum is still rolling and there is a large amount of water at high temperature in the drum.

The status is unsafe and the door cannot be opened forcefully.

Press [Start/Pause] for 3 sec. to reload, and add clothes at the midway point. Please follow the steps below:

- ❶ Wait until the drum stops rotating.
- ❷ The door is unlocked.
- ❸ Close the door when the clothes are reloaded and press the [Start/Pause] button.

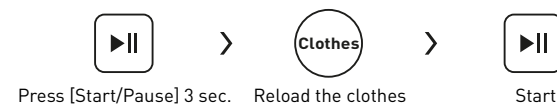
**Child Lock**

To avoid mis-operation by children.

Press [Function] and [Select] 3 sec. until the buzzer is heard.

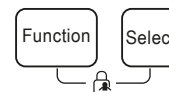

CAUTION!

When the child lock is activated and the programme starts, the child lock indicator will switch on, and the CL and remaining time on the display are alternately displayed every 0.5s. Pressing the other buttons will make the child lock indicator flash for 3s. when the programme finishes, CL and END alternate for 10s every 0.5s, then the child lock lights flash for 3s.

- Only press and hold the two button can release child lock, even power off, switch off and program end
- The "Child Lock" will lock all buttons except the Power button and Child Lock button
- Release the child lock before selecting your programme and starting washing

Temp.

Temp.

Press the button to regulate the temperature (Cold, 20°C, 30°C, 40°C, 60°C, 90°C)

Function

Option select

Select the Pre-Wash, Extra Rinse, Extra Wash, Night Wash or Anti-crease function.

Select

Option Confirm

Confirm selection of the Pre-Wash, Extra Rinse, Speed Wash, Extra Rinse or Anti-crease function.

Speed

Speed

Press the button to change the speed.

1400: 0-400-800-1200-1400

Cleaning and Care**WARNING!**

Always unplug the appliance and close the water tap before cleaning and maintenance.

Cleaning the Cabinet

Proper maintenance of the washing machine can extend its working life. The surface can be cleaned with diluted, non-abrasive neutral detergents when necessary. If there is any water overflow, use a cloth to wipe it off immediately. Never use sharp items to clean the appliance.

**CAUTION!**

Never use abrasive or caustic agents, formic acids or its diluted solvents or similar substances, like alcohol or chemical products.

Cleaning the Drum

Any rust stains left inside the drum by metal articles must be removed immediately using chlorine-free detergents. Never use steel wool for cleaning the drum!

NOTE

Keep any laundry away from the machine while cleaning the drum.

Cleaning the Door Seal and Glass

Wipe the glass and seal after each wash to remove lint and stains. If lint builds up, it can cause leakages. Remove any coins, buttons and other objects from the seal after each wash. Clean the Door Seal and Glass every month to ensure the normal operation of the appliance.

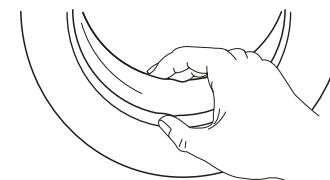

Cleaning the Inlet Filter

NOTE

Diminishing water flow is a sign that the filter needs to be cleaned.

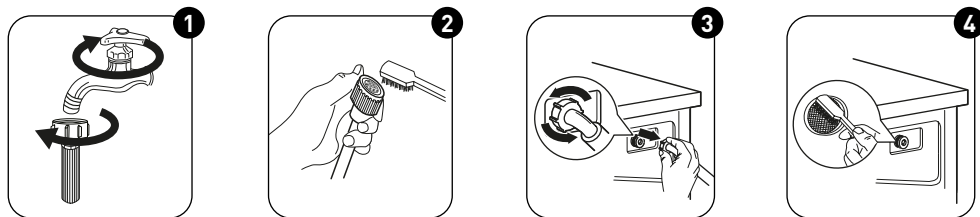

- ❶ Close the tap and remove the water supply hose from it.
- ❷ Clean the filter with a brush.
- ❸ Unscrew the water supply hose from the back of the machine. Pull out the filter using long-nose pliers.
- ❹ Use a brush to clean the filter.
- ❺ Reinstall the filter to the water inlet and reconnect the water supply hose.
- ❻ Clean the Inlet filter every 3 months to ensure the normal operation of the appliance.

Clean the Detergent Dispenser

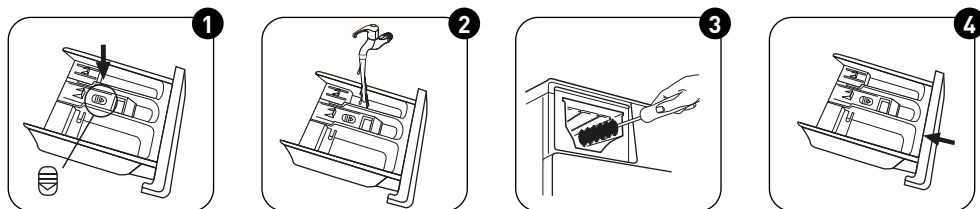

- ❶ Press the release and remove the dispenser drawer.
- ❷ Clean the dispenser drawer and softener cover under water.
- ❸ Clean the recess with a soft brush.
- ❹ Insert the dispenser drawer.

NOTE

- Do not use abrasive or caustic agents to clean plastic parts.
- Clean the detergent dispenser every 3 months to ensure the normal operation of the appliance.

Cleaning the Drain Pump Filter

WARNING!

- Be careful with hot water!
- Allow the detergent solution to cool down.
- Unplug the machine to avoid electric shock before washing.
- The drain pump filter can filter yarn and small foreign matter from the washing.
- Clean the filter periodically to ensure the normal operation of the washing machine.

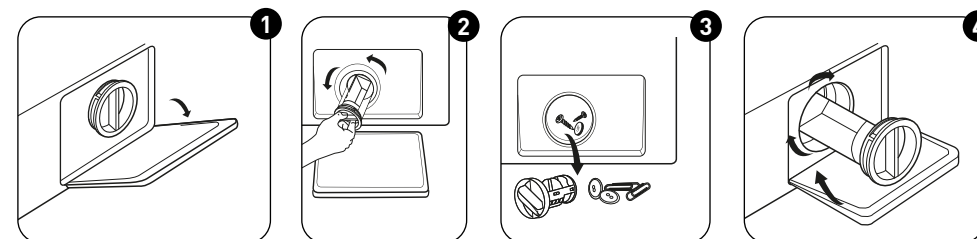

- ❶ Open the lower cover cap
- ❷ Open the filter by turning it anti-clockwise
- ❸ Remove any extraneous matter
- ❹ Close the lower cover cap

CAUTION!

- Make sure the valve cap and emergency drain hose are reinstalled properly, with the cap plates inserted to align with the hole plates, otherwise water may leak out.
- Some machines don't have an emergency drain hose, so steps 2 and 3 can be skipped. Rotate the lower cover cap directly to make water run into the basin.
- When the appliance is in use and depending on the programme selected, there may be hot water in the pump. Never remove the pump cover during a wash cycle; always wait until the appliance has finished the cycle and is empty. When replacing the cover, ensure it is securely re-tightened.

Trouble Shooting

If there is a problem with the appliance, check if you can resolve it using the tables below. If the problem persists, please contact customer services.

Description	Possible cause	Solution
Appliance does not start	Door is not closed properly. Clothes are stuck.	Close the door properly and restart. Check the laundry.
Door can't be opened	Safety protection is activated.	Disconnect the power and restart.
Water leakage	Connections are not tight enough.	Check and fasten the water inlet pipe. Check and clean the outlet hose.
Detergent residues in the detergent dispenser	Detergent is damp and/or clotted.	Clean and wipe the detergent dispenser dry.
Indicator or display does not work	PC board or harness have connection problems.	Switch off the power and check if the mains plug is connected properly.
Abnormal noise	Fixing bolts still in place. Floor is not solid or level.	Check if the fixing bolts have been removed. Make sure the appliance is installed on a solid and level floor.

Error Codes

Description	Possible cause	Solution
E30	Door is not closed properly	Close the door properly and restart.
E10	Water injecting problem during wash cycle.	Check if the water pressure is high enough. Straighten the water pipe. Clean the inlet valve filter.
E21	Overtime water draining	Check the drain hose for blockages.
E12	Water overflow	Restart the appliance.
EXX	Others	Restart the appliance. If the problem persists, please contact customer services.

Customer services

Spare parts for your appliance are available for a minimum of 10 years. In case of questions, please contact our customer services at:

WARNING!

Risk of electric shock

- Never try to repair an appliance which is defective or presumed to be defective. You may put your own and future users' lives in danger. Only authorised specialists are allowed to carry out this repair work.
- Improper repair will void the warranty and subsequent damage will not be recognised!

Transport

IMPORTANT STEPS WHEN MOVING THE APPLIANCE

- Unplug the appliance and close the water inlet tap.
- Check if the door and detergent dispenser are closed properly.
- Remove the water inlet pipe and outlet hose from the house installations.
- Let the water drain completely from the appliance (see "Maintenance Cleaning the drain pump filter")
- Important: Re-install the 4 transport bolts in the back of the appliance.
- This appliance is heavy. Transport with care. Never hold any protruding part of the machine when lifting. The machine door cannot be used as a handle.

Merci !

Nous vous remercions d'avoir choisi ce produit VALBERG.

Choisis, testés et recommandés par ELECTRO DEPOT, les produits de la marque VALBERG sont simples d'utilisation, tout en offrant des performances fiables et une qualité irréprochable.

Grâce à cet appareil, vous êtes assuré(e) que chaque utilisation vous apportera satisfaction.

Bienvenue chez ELECTRO DEPOT.

Consultez notre site Internet : www.electrodepot.fr
www.electrodepot.be

Table des matières

A

Aperçu de l'appareil

Description de l'appareil

B

Utilisation de l'appareil

Installation
Fonctionnement

C

Informations utiles

Nettoyage et entretien
Dépannage
Service client

Description de l'appareil

- ❶ Tuyau d'arrivée d'eau
- ❷ Compartiment à lessive
- ❸ Hublot
- ❹ Capot supérieur
- ❺ Panneau de commande
- ❻ Cordon d'alimentation
- ❼ Tambour
- ❽ Trappe d'entretien
- ❾ Tuyau de vidange
- ❿ 4 caches
- ⓫ 1 tuyau d'alimentation en eau froide

REMARQUE

Le visuel de l'appareil est fourni à titre indicatif uniquement, référez-vous à votre produit spécifique.

Installation

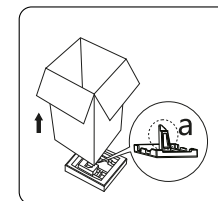
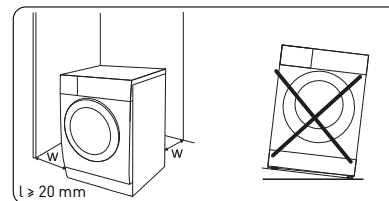

Lieu d'installation

AVERTISSEMENT !

- Il est important d'assurer une bonne stabilité pour éviter que la machine ne bouge ! Vérifiez que l'appareil est horizontal et stable.
- Assurez-vous que l'appareil ne repose pas sur le cordon d'alimentation.
- Veillez à conserver entre l'appareil et les murs les distances minimales indiquées dans l'illustration.

Avant de procéder à l'installation de l'appareil, sélectionnez un emplacement présentant les caractéristiques suivantes :

- ❶ Une surface rigide, sèche et plane ;
- ❷ À l'abri de la lumière directe du soleil ;
- ❸ Une ventilation suffisante ;
- ❹ Une température ambiante supérieure à 0 °C ;
- ❺ À l'écart des sources de chaleur, notamment des appareils alimentés au charbon ou au gaz.

Déballage du lave-linge

AVERTISSEMENT !

- Les matériaux d'emballage (par exemple, les films, le polystyrène) peuvent être dangereux pour les enfants.
- Ils présentent un risque de suffocation ! Conservez l'ensemble des emballages hors de portée des enfants.

- 1 Retirez la boîte en carton et l'emballage en polystyrène.
- 2 Soulevez le lave-linge et retirez le socle de l'emballage. Assurez-vous de retirer le petit triangle en mousse en même temps que le socle. Si ce n'est pas le cas, allongez l'appareil sur le côté et retirez-le manuellement.
- 3 Retirez le ruban adhésif retenant le cordon d'alimentation électrique et le tuyau de vidange.
- 3 Retirez le tuyau d'arrivée du tambour.

Retrait des boulons de transport

AVERTISSEMENT !

Vous devez retirer les boulons de transport situés à l'arrière de l'appareil avant de l'utiliser.



- 1 Desserrez les 4 boulons de transport à l'aide d'une clé.
- 2 Retirez les boulons, y compris les parties en caoutchouc, et conservez-les afin de pouvoir les utiliser ultérieurement.
- 3 Rebouchez les trous à l'aide des caches.

Mise à niveau du lave-linge

AVERTISSEMENT !

Les contre-écrous sur les quatre pieds doivent être bien serrés contre le corps de l'appareil.



- 1 Desserrez le contre-écrou.
- 2 Tournez le pied jusqu'à ce qu'il atteigne le sol.
- 3 Réglez les pieds et verrouillez les écrous avec une clé. Vérifiez que la machine est horizontale et stable.

Raccordement du tuyau d'arrivée d'eau

AVERTISSEMENT !

Pour éviter toute fuite ou tout dégât des eaux, veuillez suivre les instructions de ce chapitre. Veillez à ne pas tordre, écraser ni modifier le tuyau d'arrivée d'eau.

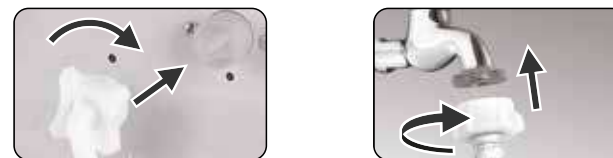

Raccordez le tuyau d'arrivée d'eau à la vanne d'arrivée d'eau et à un robinet d'eau froide, de la manière indiquée dans l'illustration.

REMARQUE

Effectuez le raccordement manuellement, sans utiliser d'outils. Vérifiez que les raccords sont bien serrés.

Tuyau de vidange

AVERTISSEMENT !

- Évitez de tordre ou de prolonger le tuyau de vidange.
- Positionnez correctement le tuyau de vidange afin d'éviter toute fuite d'eau.

Deux possibilités sont envisageables pour positionner l'extrémité du tuyau de vidange :

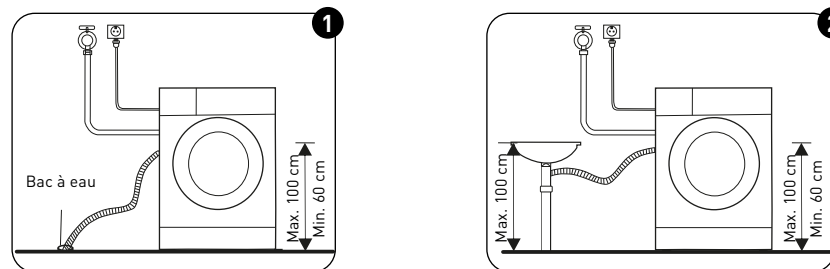

- 1 Placez-le dans le bac à eau.
- 2 Raccordez l'extrémité du tuyau au conduit de vidange de l'évier.

Fonctionnement

Prise en main rapide

ATTENTION !

- Avant de laver du linge, assurez-vous d'avoir correctement installé le lave-linge.
- Votre appareil a fait l'objet de contrôles approfondis avant de quitter l'usine. Pour retirer toute eau résiduelle et neutraliser les éventuelles odeurs, nous vous recommandons de nettoyer votre appareil avant sa première utilisation. Pour ce faire, démarrez le programme Coton à 90 °C, sans linge ni lessive.

CALIBRAGE

Il est recommandé de calibrer le lave-linge pour qu'il offre des performances optimales. L'appareil est capable de détecter la quantité de linge chargée. Cette fonction permet d'optimiser les performances de l'appareil en minimisant la consommation d'énergie et d'eau, pour gagner du temps et économiser de l'argent. De ce fait, il est conseillé de calibrer l'appareil pour une utilisation optimale.

- 1 Retirez tous les accessoires du tambour et fermez le hublot ;
- 2 Branchez la fiche dans la prise secteur ;
- 3 Allumez le lave-linge et appuyez sur les boutons Delay et Temp. simultanément pendant 10 secondes, jusqu'à ce que « t19 » s'affiche ;
- 4 Appuyez sur [▶||] pour démarrer l'appareil et attendez que « **** » s'affiche.

1 Avant le lavage

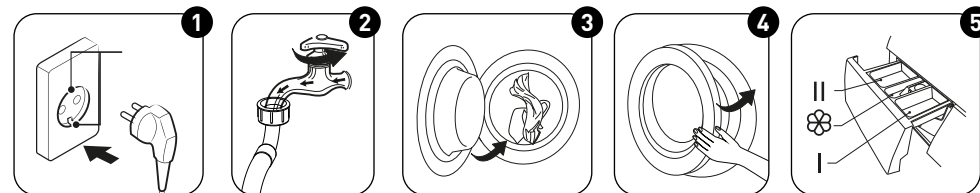

- 1 Branchez l'appareil
- 2 Ouvrez le robinet
- 3 Chargez l'appareil
- 4 Fermez le hublot
- 5 Ajoutez de la lessive

REMARQUE

La lessive doit être ajoutée dans le compartiment I si la fonction de pré-lavage a été sélectionnée.

2 Lavage

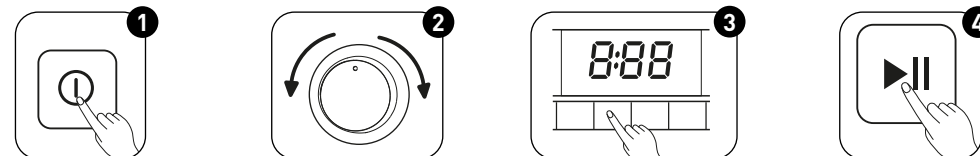

- 1 Allumez l'appareil
- 2 Sélectionnez un programme
- 3 Sélectionnez une fonction ou conservez les réglages par défaut
- 4 Appuyez sur Départ/Pause pour démarrer le programme
- 3 À la fin du lavage

Une alerte sonore retentit et « End » (Fin) s'affiche.

Avant chaque lavage

- La température ambiante de l'appareil doit se situer entre 5 et 40 °C. Si vous l'utilisez à une température inférieure à 0 °C, la vanne d'arrivée d'eau et le système de vidange risquent d'être endommagés. En cas de températures glaciales lors de l'installation du lave-linge, l'appareil doit être transféré dans une pièce à température ambiante normale pour permettre au tuyau d'arrivée d'eau et au tuyau de vidange de dégeler avant utilisation.
- Veuillez vérifier les étiquettes d'entretien de votre linge et les instructions d'utilisation de la lessive avant de procéder au lavage. Utilisez des lessives non ou peu moussantes, adaptées au lavage en machine.

AVERTISSEMENT !

- Vous ne devez jamais laver, ni sécher du linge ayant été nettoyé, lavé ou trempé dans des substances combustibles ou explosives (notamment de la cire, du pétrole, de la peinture, de l'essence, de l'alcool, du kérosène ou d'autres substances inflammables), ou ayant été taponné avec de telles substances.
- Le fait de laver un seul vêtement risque d'entraîner un défaut de centrage et de déclencher une alarme en raison du déséquilibre provoqué. Il est donc conseillé d'ajouter une ou deux pièces de linge supplémentaires pour que l'essorage puisse s'effectuer correctement.

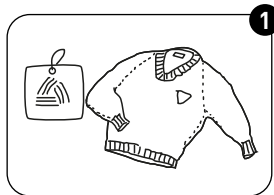

1

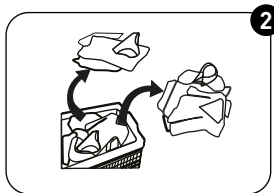

2

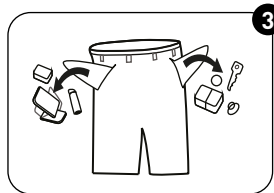

3

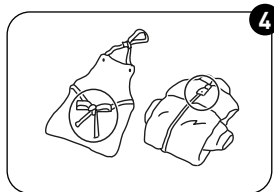

4

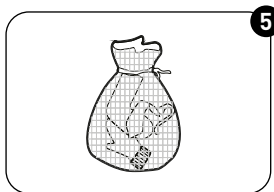

5

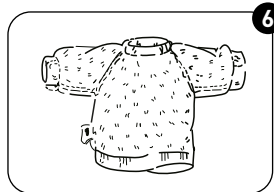

6



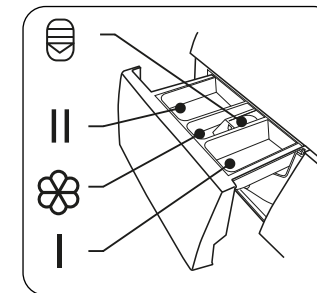













- 1 Vérifiez les étiquettes d'entretien
- 2 Triez le linge selon la couleur et le type de textile
- 3 Videz complètement les poches
- 4 Attachez ensemble les ceintures et les longues lanières textiles, fermez les boutons et les fermetures à glissière
- 5 Placez les petits articles dans un filet à linge
- 6 Mettez sur l'envers les tissus qui boulochent facilement ou à poils longs

Compartment à lessive

- I Prélavage
- II Lavage principal
- III Assouplissant
- IV Bouton de déverrouillage permettant de sortir le compartiment

ATTENTION !

La lessive ne doit être mise dans le « compartiment I » que si vous avez sélectionné la fonction Prélavage.

Programme	I	II	
 Synthétique	<input type="radio"/>	<input checked="" type="radio"/>	<input type="radio"/>
 Mélange	<input type="radio"/>	<input checked="" type="radio"/>	<input type="radio"/>
 Rapide 45'	<input type="radio"/>	<input checked="" type="radio"/>	<input type="radio"/>
 Rapide 15'		<input checked="" type="radio"/>	<input type="radio"/>
 Laine		<input checked="" type="radio"/>	<input type="radio"/>
 Anti-allergie	<input type="radio"/>	<input checked="" type="radio"/>	<input type="radio"/>
 Vapeur	<input type="radio"/>	<input checked="" type="radio"/>	<input type="radio"/>
 Rinçage & Essorage			<input type="radio"/>
 Essorage uniquement			
 Vêtements de sport	<input type="radio"/>	<input checked="" type="radio"/>	<input type="radio"/>
 20 °C		<input checked="" type="radio"/>	<input type="radio"/>
 Jeans	<input type="radio"/>	<input checked="" type="radio"/>	<input type="radio"/>
 ÉCO 40-60		<input checked="" type="radio"/>	<input type="radio"/>
 Intensif		<input checked="" type="radio"/>	<input type="radio"/>
 Coton	<input type="radio"/>	<input checked="" type="radio"/>	<input type="radio"/>

● Obligatoire ○ Facultatif

Recommandations concernant les lessives

Lessive recommandée	Cycles de lavage	Temp. de lavage	Types de linge et de textiles
Lessive puissante contenant des agents de blanchiment et des azurants optiques	Coton ÉCO 40-60 Mélange, Jeans, Intensif	20/30/40/60	Linge blanc en lin ou coton qui peut bouillir
Lessive pour couleurs ne contenant pas d'agents de blanchiment ni d'azurants optiques	Coton ÉCO 40-60 Mélange, Jeans, Intensif	À froid/20/30/40	Linge de couleur en coton ou lin
Lessive douce ou pour couleurs, sans azurants optiques	Synthétique	À froid/20/30/40	Linge de couleur, composé de matières synthétiques ou de fibres faciles d'entretien
Lessive douce	Synthétique	20/30	Textiles délicats, soie, viscose
Lessive spéciale laine	Laine	20/30	Laine

REMARQUES

- Si la lessive ou l'additif présentent un aspect aggloméré ou visqueux, ils peuvent être dilués dans de l'eau avant de les verser dans le compartiment à lessive, de manière à éviter de bloquer son orifice et de provoquer un débordement d'eau.
- Veuillez choisir le type de lessive adapté afin d'obtenir des performances de lavage optimales, tout en consommant le moins d'eau et d'énergie possible.
- Pour un lavage optimal, il est important de doser correctement la lessive.
- Utilisez une quantité réduite de lessive si le tambour n'est pas complètement rempli.
- Adaptez toujours la quantité de lessive en fonction de la dureté de l'eau : si votre eau du robinet est peu calcaire, utilisez moins de lessive.
- Dosez la lessive en fonction du degré de salissure de votre linge : des vêtements peu sales nécessitent moins de lessive.
- Les lessives très concentrées requièrent un dosage particulièrement précis.

Les symptômes suivants évoquent un surdosage de lessive :

- la formation d'une mousse importante ;
- de mauvaises performances de lavage et de rinçage.

Les symptômes suivants évoquent un dosage de lessive insuffisant :

- le linge devient gris ;
- des dépôts de calcaire s'accumulent sur le tambour, l'élément chauffant et/ou le linge.

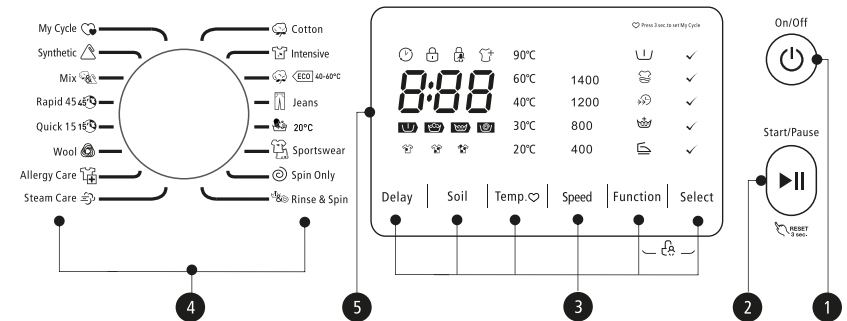
Panneau de commande**1 Alimentation**

Permet d'allumer et d'éteindre l'appareil.

2 Départ/Pause

Permet de démarrer ou d'interrompre votre programme.

3 Options

Permettent de sélectionner des fonctions supplémentaires. Le témoin lumineux correspondant s'allume une fois que l'option a été sélectionnée.

4 Programmes

Disponibles selon le type de linge.

5 Écran

L'écran indique les réglages, le temps restant estimé, les options et les messages d'état.

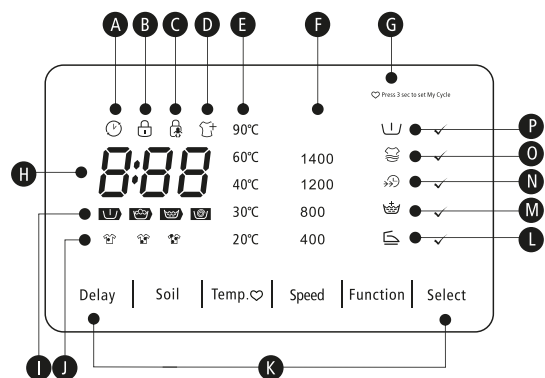

A Départ différé

B Verrouillage du hublot

C Sécurité enfants

D Rajout de linge

E Temp.

F Vitesse

G Mon Cycle

H Durée du lavage Départ différé Erreur Fin
 125 2h E20 End

I Prélavage-lavage-rinçage-essorage

J Niveau de salissure

K Options

L Anti-froissage

M Rinçage supplémentaire

N Lavage rapide

O Lavage supplémentaire







P Prélavage

Programmes

Programme	Charge (kg)			Durée affichée
> CAPACITÉ MACHINE	7,0	8,0	12,0	7,0/8,0/12,0
Coton	7,0	8,0	12,0	3:39
Intensif	7,0	8,0	12,0	3:48
ÉCO 40-60°C	7,0	8,0	12,0	3:13/3:32/3:56
Jeans	7,0	8,0	12,0	1:35
20 °C	3,5	4,0	6,0	1:01
Vêtements de sport	3,5	4,0	6,0	0:45
Essorage uniquement	7,0	8,0	12,0	0:12
Rinçage & Essorage	7,0	8,0	12,0	0:20
Vapeur	7,0	8,0	12,0	1:47
Anti-allergie	3,5	4,0	6,0	2:09
Laine	2,0	2,0	2,0	1:07
Rapide 15'	2,0	2,0	2,0	0:15
Rapide 45'	2,0	2,0	2,0	0:45
Mélange	7,0	8,0	6,0	1:20
Synthétique	3,5	4,0	6,0	3:17







- Les données ci-dessus sont fournies à titre indicatif uniquement et peuvent varier en fonction des conditions d'utilisation réelles.
- Les valeurs indiquées pour les programmes autres qu'ÉCO 40-60 sont fournies à titre indicatif uniquement.
- Concernant le règlement (UE) n°1061/2010 :
La classe d'efficacité énergétique européenne est : A+++
Programme de test énergétique : Intensif 60/40 °C ; Vitesse : vitesse maximale ; autres réglages par défaut.
Demi-charge pour une machine de 7,0/8,0/12,0 kg : 3,5/4,0/6,0 kg.
- Concernant le règlement (UE) n°2019/2023 :
La classe d'efficacité énergétique européenne est : B
Programme de test énergétique : ÉCO 40-60. Autres réglages par défaut.
Demi-charge pour une machine de 7,0/8,0/12,0 kg : 3,5/4,0/6,0 kg.
Quart de charge pour une machine de 7,0/8,0/12,0 kg : 2,0/2,0/3,0 kg.

Programmes

Cycle	Capacité nominale en kg	Durée du cycle en heures et minutes	Consommation d'énergie en kWh/cycle de fonctionnement	Consommation d'eau en litres/cycle de fonctionnement	Température la plus élevée en °C	Humidité résiduelle en %/vitesse d'essorage
 20°C	3,5	1:01	0,100	45	20	65 %/1 000
 Coton (60°C)	7,0	3:44	1,392	65	60	53 %/1 400
 Intensif	7,0	3:48	1,000	68	40	70 %/800
 Mélange	7,0	1:20	0,710	60	40	70 %/800
 Rapide 15'	2,0	0:15	0,030	40	Cold	75 %/800
	7,0	-	0,775	54	36	53 %/1 400
  40-60°C	3,5	-	0,47	44	34	53 %/1 400
	2,0	-	0,2	35	21	53 %/1 400







- Les données ci-dessus sont fournies à titre indicatif uniquement et peuvent varier en fonction des conditions d'utilisation réelles.
- Les valeurs indiquées pour les programmes autres qu'ÉCO 40-60 sont fournies à titre indicatif uniquement.
- Concernant le règlement (UE) n°1061/2010 :
La classe d'efficacité énergétique européenne est : A+++
Programme de test énergétique : Intensif 60/40 °C ; Vitesse : vitesse maximale ; autres réglages par défaut.
Demi-charge pour une machine de 7,0 kg : 3,5 kg.
- Concernant le règlement (UE) n°2019/2023 :
La classe d'efficacité énergétique européenne est : B
Programme de test énergétique : ÉCO 40-60. Autres réglages par défaut.
Demi-charge pour une machine de 7,0 kg : 3,5 kg.
Quart de charge pour une machine de 7,0 kg : 2,0 kg.

Programmes

Cycle 8kg	Capacité nominale en kg	Durée du cycle en heures et minutes	Consommation d'énergie en kWh/cycle de fonctionnement	Consommation d'eau en litres/cycle de fonctionnement	Température la plus élevée en °C	Humidité résiduelle en %/vitesse d'essorage
 20°C	4,0	1:01	0,15	50	20	65 %/1 000
 Coton (60°C)	8,0	3:44	1,498	70	60	53 %/1 400
 Intensif	8,0	3:48	1,100	70	40	70 %/800
 Mélange	8,0	1:20	0,75	65	40	70 %/800
 Rapide 15'	2,0	0:15	0,030	40	Cold	75 %/800
	8,0	-	0,857	59	34	53 %/1 400
  40-60°C	4,0	-	0,504	46	29	53 %/1 400
	2,0	-	0,24	37	21	53 %/1 400

- Les données ci-dessus sont fournies à titre indicatif uniquement et peuvent varier en fonction des conditions d'utilisation réelles.
- Les valeurs indiquées pour les programmes autres qu'ÉCO 40-60 sont fournies à titre indicatif uniquement.
- Concernant le règlement (UE) n°1061/2010 :
La classe d'efficacité énergétique européenne est : A+++
Programme de test énergétique : Intensif 60/40 °C ; Vitesse : vitesse maximale ; autres réglages par défaut.
Demi-charge pour une machine de 8,0 kg : 4,0 kg.
- Concernant le règlement (UE) n°2019/2023 :
La classe d'efficacité énergétique européenne est : B
Programme de test énergétique : ÉCO 40-60. Autres réglages par défaut.
Demi-charge pour une machine de 8,0 kg : 4,0 kg.
Quart de charge pour une machine de 8,0 kg : 2,0 kg.

Programmes

Cycle 12kg	Capacité nominale en kg	Durée du cycle en heures et minutes	Consommation d'énergie en kWh/cycle de fonctionnement	Consommation d'eau en litres/cycle de fonctionnement	Température la plus élevée en °C	Humidité résiduelle en %/vitesse d'essorage
 20°C	6,0	1:01	0,206	58	20	65 %/1 000
 Coton (60°C)	12,0	3:44	1,919	99	60	53 %/1 400
 Intensif	12,0	3:48	1,417	99	40	70 %/800
 Mélange	12,0	1:20	0,988	99	40	70 %/800
 Rapide 15'	2,0	0:15	0,030	40	15	75 %/800
	12,0	-	1,345	87	40	53 %/1 400
  40-60°C	6,0	-	0,858	62	38	53 %/1 400
	3,0	-	0,242	42	20	53 %/1 400

- Les données ci-dessus sont fournies à titre indicatif uniquement et peuvent varier en fonction des conditions d'utilisation réelles.
- Les valeurs indiquées pour les programmes autres qu'ÉCO 40-60 sont fournies à titre indicatif uniquement.
- Concernant le règlement (UE) n°2019/2023 :
La classe d'efficacité énergétique européenne est : B
Programme de test énergétique : ÉCO 40-60. Autres réglages par défaut.
Demi-charge pour une machine de 12,0 kg : 6,0 kg.
Quart de charge pour une machine de 12,0 kg : 3,0 kg.

- ❶ Température la plus élevée atteinte par le linge au cours du cycle de lavage pendant au moins 5 minutes.
- ❷ Humidité résiduelle après le cycle de lavage en pourcentage de teneur en eau et vitesse d'essorage à laquelle cette valeur a été obtenue.
- ❸ Le programme ÉCO 40-60 permet de laver du linge en coton normalement sale, indiqué comme pouvant être lavé ensemble à 40 °C ou 60 °C, au cours du même cycle. Ce programme est utilisé pour évaluer la conformité au règlement (UE) 2019/2023.

Les programmes les plus économes en termes de consommation d'énergie sont généralement ceux qui fonctionnent à des températures plus basses et pendant une plus longue durée.

Le chargement du lave-linge domestique en respectant la capacité maximale indiquée pour le programme concerné contribue à la réalisation d'économies d'énergie et d'eau.

Le bruit et la teneur en humidité résiduelle dépendent de la vitesse d'essorage : plus cette vitesse est élevée au cours de la phase d'essorage, plus le bruit est important et plus la teneur en humidité résiduelle est basse.

ATTENTION !

En cas de coupure de courant au cours du fonctionnement de la machine, une mémoire spéciale enregistre le programme sélectionné. Le programme reprendra une fois que le courant sera rétabli.

Programmes

Les programmes suivants sont disponibles selon le type de linge.

Programmes

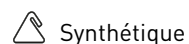

Synthétique

Lavage d'articles synthétiques, par exemple : chemises, manteaux, tissus mélangés.

Pour le lavage des textiles en maille, il convient de réduire la quantité de lessive ; les mailles du tissu étant lâches, celles-ci favorisent la formation de mousse. Textiles solides et résistant à la chaleur en coton ou en lin.

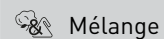

Mélange

Mélange de linge en coton et de textiles synthétiques.



Rapide 45'

Ce programme convient pour le lavage de vêtements peu sales. Il permet de consommer moins d'énergie.

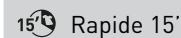

Rapide 15'

Programme très court, convenant à de petites quantités de linge légèrement sale.



Laine

Pour la laine lavable à la main ou en machine ou les textiles riches en laine. Il s'agit d'un programme de lavage particulièrement doux qui évite le rétrécissement du linge, avec des pauses plus longues pendant le programme (les textiles trempent dans le liquide de lavage).



Anti-allergie

Le lave-linge permet d'éliminer efficacement certains allergènes et d'avoir un effet anti-allergène en ayant recours à une température élevée de 60 °C à des fins de stérilisation.



Vapeur

Ce programme est destiné au linge quotidien, comme le coton et les matières synthétiques. La vapeur pénètre en profondeur dans les fibres, ce qui élimine efficacement les bactéries et les microbes, empêchant la formation d'odeurs et protégeant votre santé.



Rinçage & Essorage

Rinçage supplémentaire avec un essorage.



Essorage uniquement

Essorage supplémentaire avec une vitesse d'essorage sélectionnable.



Vêtements de sport

Lavage des vêtements de sport.



20°C

Réglage sur 20 °C par défaut. Possibilité d'opter pour de l'eau froide.



Jeans

Programme spécial pour les jeans.



ECO 40-60°C

Réglage sur 40 °C par défaut. Non modifiable. Convient au lavage de linge à environ 40 °C - 60 °C.



Intensif



































































Pour obtenir de meilleurs résultats, le temps de lavage est plus long.



Coton

Textiles solides et résistant à la chaleur en coton ou en lin.

Options

Cycle	Temp. par défaut (°C)	Vitesse d'essorage par défaut en t/min	Fonctions supplémentaires
Cycles de lavage		1 400	
 Synthétique	40	1 200	    
 Mélange	40	800	    
 Rapide 45'	40	800	   
 Rapide 15'	À froid	800	
 Laine	40	800	  
 Anti-allergie	60	800	    
 Vapeur	40	800	    
 Rinçage & Essorage	-	800	  
 Essorage uniquement	-	800	 
 Vêtements de sport	20	800	   
 20 °C	20	800	  
 Jeans	30	800	   
 ÉCO 40-60	-	1 400	
 Intensif	40	800	
 Coton	40	1 400	    

REMARQUES

- Pour plus d'informations sur la vitesse d'essorage maximale, la durée des programmes et d'autres renseignements sur le programme ÉCO 40-60, veuillez consulter la page Fiche produit.
- Le tableau indique les options disponibles pour chaque cycle.

Temp.

Temp.

Si nécessaire, vous pouvez appuyer sur ce bouton pour régler la température de lavage dans l'ordre suivant : à froid - 20 °C - 30 °C - 40 °C - 60 °C - 90 °C.

Delay

Départ différé

Réglage de la fonction de départ différé :

- 1 Sélectionnez un programme ;
- 2 Appuyez sur le bouton Départ différé pour choisir la durée (la durée du départ différé est comprise entre 0 et 24 h) ;
- 3 Appuyez sur le bouton Départ/Pause pour lancer le départ différé.



Choisissez le programme



Réglez la durée



Lancez le programme

Annulation de la fonction de départ différé :

Appuyez sur le bouton Delay jusqu'à ce que « 0h » s'affiche. Vous devez appuyer dessus avant de démarrer le programme. Si le programme est déjà lancé, arrêtez-le pour en régler un nouveau.

Soil

Salissure

La durée de lavage augmentera ou diminuera si vous sélectionnez ce bouton.

**Prélavage**

La fonction de prélavage permet d'effectuer un lavage supplémentaire avant le lavage principal, afin d'éliminer la poussière qui remonte à la surface des vêtements. Une fois cette fonction sélectionnée, vous devez ajouter de la lessive dans le compartiment (I).

**Lavage supplémentaire**

Cette fonction est destinée aux vêtements très sales. Si vous la sélectionnez, la durée et l'intensité du lavage seront accrues pour renforcer l'efficacité du lavage.

**Lavage rapide**

Cette fonction permet de réduire la durée du lavage.

**Rinçage supplémentaire**

Lorsque vous sélectionnez cette fonction, votre linge subit un rinçage supplémentaire.

**Mon Cycle**

Permet de mémoriser le programme le plus fréquemment utilisé.

Après avoir choisi le programme et réglé les options, appuyez sur le bouton Temp. pendant 3 secondes avant de lancer le lavage. Le programme défini par défaut est le programme Coton.

**Anti-froissage**

Cette fonction permet d'obtenir des vêtements moins froissés.

**Rajout de linge**

Cette opération peut être effectuée au cours du lavage. Pendant que le tambour tourne encore et qu'il reste une grande quantité d'eau et une température élevée dans le tambour,

il est impossible de forcer l'ouverture du hublot, car cela est dangereux.

Appuyez sur le bouton Départ/Pause pendant 3 secondes pour utiliser cette fonction et rajouter des vêtements en cours de cycle. Veuillez suivre les étapes ci-dessous :

- 1 Attendez que le tambour cesse de tourner ;
- 2 Le verrouillage du hublot est désactivé ;
- 3 Ajoutez les vêtements, puis fermez le hublot et appuyez sur le bouton Départ/Pause.



Appuyez sur Départ/Pause pendant 3 secondes

Ajoutez les vêtements

Lancez le programme

**Sécurité enfants**

Permet d'éviter toute mauvaise manipulation par des enfants.

Appuyez sur les boutons Fonctions et Sélection pendant 3 secondes, jusqu'à ce qu'un signal sonore retentisse.



ATTENTION !

Lorsque la Sécurité enfants est activée et que le programme démarre, le témoin de la Sécurité enfants s'allume. L'indication « CL » (Sécurité enfants) et le temps restant s'afficheront alors en alternance toutes les 0,5 s.

Si vous appuyez sur les autres boutons, le témoin de la Sécurité enfants clignotera pendant 3 s. À la fin du programme, « CL » et « END » s'afficheront en alternance pendant 10 s, puis le témoin de la Sécurité enfants clignotera pendant 3 s.

- Pour désactiver la Sécurité enfants, il suffit d'appuyer sur les deux boutons et de les maintenir enfoncés, même en cas de coupure de courant, d'extinction de l'appareil et après la fin du programme.
- La Sécurité enfants verrouillera tous les boutons, hormis le bouton d'alimentation et le bouton Sécurité enfants.
- Veuillez désactiver la Sécurité enfants avant de sélectionner et de lancer un programme.

Temp.

Temp.

Appuyez sur ce bouton pour régler la température (à froid, 20 °C, 30 °C, 40 °C, 60 °C, 90 °C).

Fonction

Sélection d'option

Permet de sélectionner les fonctions Pre Wash, Extra Rinse, Extra Wash, Night Wash ou Anti-crease.

Select

Confirmation d'option

Permet de confirmer la sélection des fonctions Pre Wash, Extra Rinse, Speed Wash, Night Wash or Anti-crease.

Speed

Vitesse

Appuyez sur ce bouton pour modifier la vitesse.
1 400 : 0 - 400 - 800 - 1 200 - 1 400

Nettoyage et entretien**AVERTISSEMENT !**

Débranchez toujours l'appareil et fermez le robinet d'eau avant les opérations de nettoyage et d'entretien.

Nettoyage du corps de l'appareil

Un entretien adéquat du lave-linge permet d'allonger sa durée de vie. Les surfaces peuvent être nettoyées à l'aide de détergents neutres non abrasifs et dilués, si nécessaire. En cas de débordement, utilisez un chiffon pour absorber immédiatement l'eau. N'utilisez jamais d'objets pointus pour nettoyer l'appareil.

**ATTENTION !**

N'utilisez jamais de produits caustiques, d'acide formique ou ses solvants dilués, ni de substances similaires, comme de l'alcool ou des produits chimiques.

Nettoyage du tambour

Toutes taches de rouille laissées à l'intérieur du tambour par des articles en métal doivent être retirées immédiatement, à l'aide de détergents sans chlore. N'utilisez jamais de paille de fer pour nettoyer le tambour !

REMARQUE

Éloignez le linge de la machine pendant que vous nettoyez le tambour.

Nettoyage du joint et du verre du hublot

Essuyez le verre et le joint après chaque lavage pour éliminer les peluches et les taches. Une accumulation de peluches risque de provoquer des fuites. Retirez les éventuels boutons, pièces et autres objets du joint après chaque lavage.

Nettoyez le joint et le verre du hublot chaque mois afin d'assurer le bon fonctionnement de l'appareil.

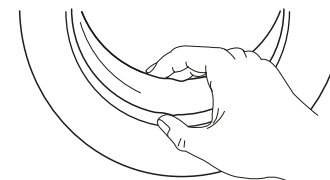

Nettoyage du filtre d'entrée**REMARQUE**

Un débit d'eau en baisse indique que le filtre a besoin d'être nettoyé.

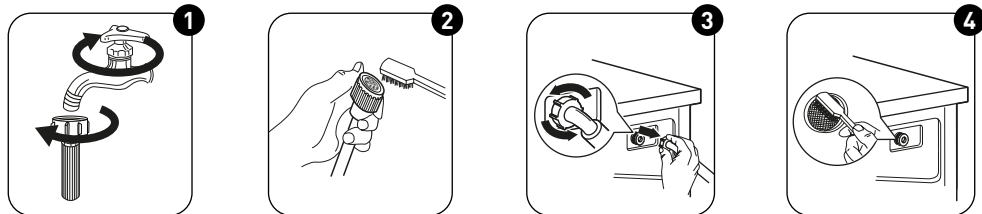

- ❶ Fermez le robinet et retirez le tuyau d'arrivée d'eau.
- ❷ Nettoyez le filtre à l'aide d'une brosse.
- ❸ Dévissez le tuyau d'arrivée d'eau de l'arrière de la machine. Sortez le filtre à l'aide d'une pince à long bec.
- ❹ Utilisez une brosse pour nettoyer le filtre.
- ❺ Réinstallez le filtre sur l'arrivée d'eau et rebranchez le tuyau d'arrivée d'eau.
- ❻ Nettoyez le filtre d'entrée tous les 3 mois pour assurer le bon fonctionnement de l'appareil.

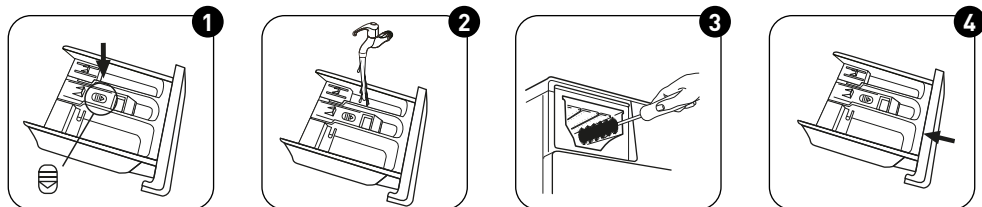
Nettoyage du compartiment à lessive

- ❶ Appuyez sur le bouton de déverrouillage et sortez le compartiment.
- ❷ Nettoyez le compartiment à lessive et le couvercle de l'assouplissant sous l'eau.
- ❸ Nettoyez le logement à l'aide d'une brosse douce.
- ❹ Réinsérez le compartiment.

REMARQUES

- N'utilisez pas de produits abrasifs ou caustiques pour nettoyer les pièces en plastique.
- Nettoyez le compartiment à lessive tous les 3 mois pour assurer le bon fonctionnement de l'appareil.

Nettoyage du filtre de la pompe de vidange**AVERTISSEMENT !**

- Prenez garde à l'eau chaude !
- Laissez la solution de détergent refroidir.
- Débranchez la machine avant le nettoyage pour éviter tout choc électrique.
- Le filtre de la pompe de vidange filtre les fils et petits corps étrangers provenant du lavage.
- Nettoyez périodiquement le filtre afin de garantir un fonctionnement optimal du lave-linge.

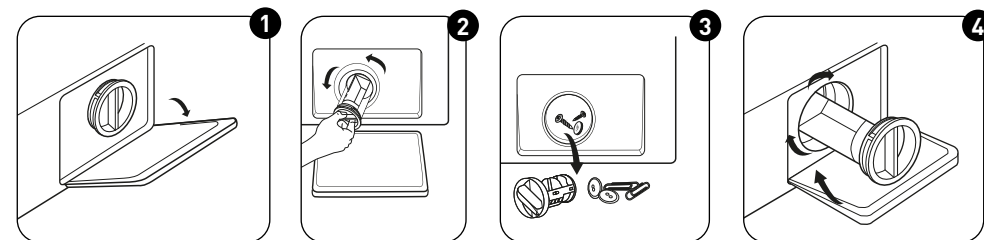

- ❶ Ouvrez le cache inférieur ;
- ❷ Ouvrez le filtre en le tournant dans le sens inverse des aiguilles d'une montre ;
- ❸ Retirez les corps étrangers ;
- ❹ Fermez le cache inférieur.

ATTENTION !

- Assurez-vous de remettre en place correctement le bouchon de valve et le tuyau de vidange d'urgence ; les plaques de recouvrement doivent être insérées en les alignant avec les plaques perforées, sans quoi des fuites peuvent survenir.
- Certains appareils ne sont pas équipés d'un tuyau de vidange d'urgence ; les étapes 2 et 3 peuvent alors être ignorées. Tournez directement le cache inférieur pour faire écouler l'eau dans une bassine.
- Lorsque la machine est en marche et selon le programme sélectionné, il est possible que la pompe contienne de l'eau chaude. Ne retirez jamais le cache de la pompe au cours d'un cycle de lavage, attendez toujours que la machine ait terminé son cycle et soit vide. Lorsque vous remplacez le cache, assurez-vous de le resserrer correctement.

Dépannage

En cas de problème avec l'appareil, tentez de le résoudre à l'aide des tableaux ci-dessous. Si le problème persiste, veuillez contacter le Service client.

Description	Causes potentielles	Solutions
L'appareil ne démarre pas	Le hublot n'est pas correctement fermé. Des vêtements sont coincés.	Fermez correctement le hublot et redémarrez l'appareil. Vérifiez le linge.
Le hublot ne s'ouvre pas	La protection de sécurité est activée.	Débranchez l'appareil puis redémarrez-le. Vérifiez et fixez le tuyau d'arrivée d'eau.
Fuite d'eau	Les raccords ne sont pas suffisamment serrés.	Vérifiez et nettoyez le tuyau d'évacuation.
Présence de résidus de lessive dans le compartiment à lessive	La lessive est humide et/ou coagulée.	Nettoyez et essuyez le compartiment à lessive.
Les témoins lumineux ou l'écran ne fonctionnent pas	La carte de circuit imprimé ou le câblage présentent des problèmes de connexion.	Coupez l'alimentation et vérifiez si la fiche est correctement branchée.
Bruits anormaux	Les boulons de fixation sont encore en place. Le sol n'est pas solide ou horizontal.	Vérifiez que les boulons de fixation ont bien été retirés. Assurez-vous que l'appareil est installé sur une surface plane et solide.

Codes d'erreur

Description	Causes potentielles	Solutions
E30	Le hublot n'est pas correctement fermé	Fermez correctement le hublot et redémarrez l'appareil.
E10	Problème d'injection d'eau au cours du cycle de lavage	Vérifiez si la pression d'eau est suffisante. Redressez le tuyau d'eau. Nettoyez le filtre de la vanne d'alimentation.
E21	Vidange de l'eau trop longue	Vérifiez si le tuyau de vidange est obstrué.
E12	Débordement d'eau	Redémarrez l'appareil.
EXX	Autres	Redémarrez l'appareil. Si le problème persiste, veuillez contacter le Service client.

Service client

Des pièces détachées seront disponibles pour votre appareil pendant au moins 10 ans. En cas de questions, veuillez contacter notre Service client :

AVERTISSEMENT !

Risque de choc électrique

- N'essayez jamais de réparer un appareil qui est défectueux ou présumé défectueux. Vous pourriez mettre en péril votre vie et celles des futurs utilisateurs. Seuls des spécialistes agréés sont autorisés à effectuer de telles réparations.
- Des réparations inappropriées annuleraient la garantie et les dommages consécutifs ne seraient pas reconnus !

Transport

ÉTAPES IMPORTANTES À SUIVRE POUR DÉPLACER L'APPAREIL

- Débranchez l'appareil et fermez le robinet d'arrivée d'eau.
- Vérifiez si le hublot et le compartiment à lessive sont bien fermés.
- Retirez le tuyau d'arrivée d'eau et le tuyau d'évacuation du corps de l'appareil.
- Laissez toute l'eau s'écouler de l'appareil (voir la rubrique « Nettoyage du filtre de la pompe de vidange »).
- Remarque importante : réinstallez les 4 boulons de transport à l'arrière de l'appareil.
- Cet appareil est lourd. Transportez-le avec précaution. Ne tenez jamais une partie saillante de l'appareil pour le soulever. Le hublot de la machine ne peut pas servir de poignée.

Dank u!

Dank u om dit VALBERG-product te kiezen. De producten van het merk VALBERG, die gekozen, getest en aanbevolen worden door ELECTRO DEPOT, zijn eenvoudig te gebruiken, betrouwbaar en van onberispelijke kwaliteit. Dankzij dit toestel kunt u er zeker van zijn dat u bij elk gebruik volledig tevreden zult zijn.

Welkom bij ELECTRO DEPOT.

Inhoudstafel

A Voorbeeldweergave
van het toestel

Beschrijving van het toestel

B Het toestel gebruiken

Installatie
Werking

C Nuttige informatie

Reiniging en onderhoud
Depannage
Klantendienst

Beschrijving van het toestel

- ❶ Watertoevoerslang
- ❷ Wasmiddeldispenser
- ❸ Deur
- ❹ Deksel bovenaan
- ❺ Bedieningspaneel
- ❻ Stroomkabel
- ❼ Trommel
- ❽ Serviceklep
- ❾ Afvoerslang
- ❿ 4 x Afdekkapjes
- ⓫ 1 x Toevoerslang voor koud water

OPMERKING

De productafbeelding is louter ter illustratie. Zie het echte product als referentie.

Installatie

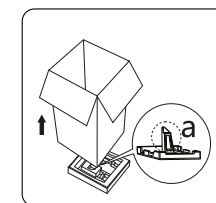
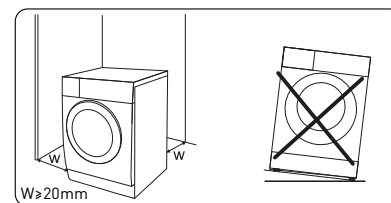

Installatieruimte

WAARSCHUWING!

- Stabiliteit is belangrijk om te voorkomen dat het toestel zich verplaatst! Zorg ervoor dat de machine waterpas en stabiel staat.
- Zorg ervoor dat het product niet op de stroomkabel staat.
- Zorg ervoor dat de minimale afstanden van de muren wordt behouden, zoals weergegeven op de afbeelding

Alvorens de machine te installeren, zullen de locatiekenmerken als volgt worden geselecteerd:

- ❶ Stevig, droog en vlak oppervlak
- ❷ Vermijd rechtstreeks zonlicht
- ❸ Voldoende ventilatie
- ❹ De kamertemperatuur ligt hoger dan 0°C
- ❺ Houd uit de buurt van hittebronnen, zoals toestellen die steenkool of gas verbranden.

De wasmachine uitpakken

WAARSCHUWING!

- De verpakkingsmaterialen (bijv. folies, piepschuim) kunnen gevaarlijk zijn voor kinderen.
- Er bestaat een risico op verstikking! Houd alle verpakkingsmaterialen uit de buurt van kinderen.

- ❶ Verwijder de kartonnen doos en de piepschuim verpakking.
- ❷ Til de wasmachine op en verwijder de verpakking onderaan. Zorg ervoor dat de kleine piepschuim driehoek (a) samen met de bodemverpakking wordt verwijderd. Zo niet, leg de eenheid op de zijkant en verwijder deze met de hand.

- 3 Verwijder de kleefband waarmee de stroomkabel en de afvoerslang zijn vastgemaakt.
- 4 Verwijder de inlaatslang uit de trommel.

Verwijder de transportschroeven

WAARSCHUWING!

U moet de transportschroeven aan de achterkant verwijderen alvorens het product te gebruiken.



- 1 Draai de 4 transportschroeven los met een steeksleutel.
- 2 Verwijder de schroeven en de rubber onderdelen en bewaar ze voor toekomstig gebruik.
- 3 Sluit de gaten af met de afdekkapjes van het deksel.

De wasmachine waterpas zetten

WAARSCHUWING!

De vergrendelmoeren op alle vier de voeten moeten vastgeschroefd worden tegen de behuizing.



- 1 Draai de vergrendelmoer los.
- 2 Draai de voet tot deze de vloer raakt.
- 3 Pas de voeten aan en draai de moreen vast met een steeksleutel. Zorg ervoor dat de machine vlak en stevig staat.

Sluit de watertoevoerslang aan

WAARSCHUWING!

Volg de instructies in dit hoofdstuk om lekken of waterschade te voorkomen.

- Knik, plet of wijzig de watertoevoerslang niet.

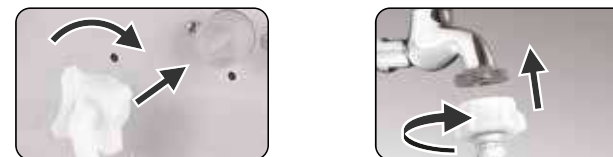

Sluit de watertoevoerslang aan op de watertoevoerklep en een waterkraan voor koud water, zoals aangegeven

OPMERKING

Sluit manueel aan, gebruik geen gereedschap. Controleer of de aansluitingen stevig zijn.

Afvoerslang

WAARSCHUWING!

- Knik of verleng de afvoerslang niet.
- Plaats de afvoerslang naar behoren om schade als gevolg van waterlekken te voorkomen

Er zijn twee manieren om het uiteinde van de afvoerslang te plaatsen:

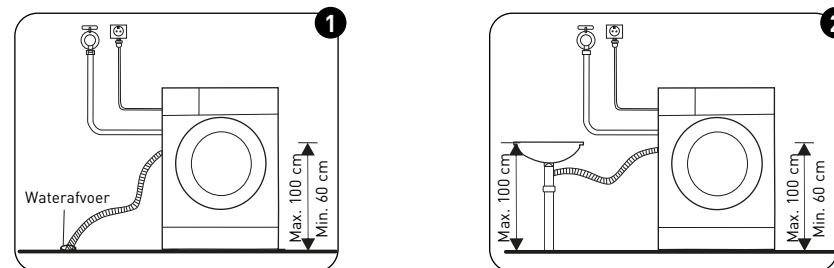

- 1 Plaats het in de waterafvoer.
- 2 Sluit het aan op de afvoerpijp van de watertoevoer.

Werking

Quick Start

OPGELET!

- Alvorens te wassen, zorg er voor dat de wasmachine naar behoren geïnstalleerd is.
- Uw toestel werd grondig gecontroleerd alvorens het de fabriek verliet. Om resterend water te verwijderen en potentiële geurtjes te neutraliseren. Het is aanbevolen om uw toestel te reinigen alvorens het voor het eerst te gebruiken. Start hiervoor het programma Katoen op 90°C zonder wasgoed en wasmiddel.

IJKING

Het is aanbevolen om de wasmachine te ijken zodat ze de beste prestaties levert. Het toestel kan de hoeveelheid geladen wasgoed detecteren. Deze functie optimaliseert de prestaties van het product door het energie- en waterverbruik te verminderen, waardoor u tijd en geld bespaart. Daarom is het aanbevolen om het toestel te ijken zodat het optimaal kan worden gebruikt.

- 1 Verwijder alle toebehoren uit de trommel en sluit de deur;
- 2 Stop de stekker in het stopcontact;
- 3 Schakel het toestel in en druk gelijktijdig 10 seconden lang op "Delay" en "Temp." tot "t19" wordt weergegeven;
- 4 Druk op [▶||] om het toestel te starten en wacht tot "****" wordt weergegeven.

1 Alvorens te wassen

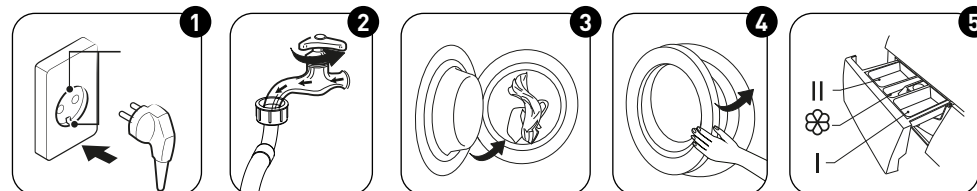

- 1 Stop de stekker in het stopcontact
- 2 Draai de kraan open
- 3 Laad het toestel in
- 4 Sluit de deur
- 5 Voeg wasmiddel toe

OPMERKING

Er moet wasmiddel worden toegevoegd compartiment I indien een voorwasfunctie wordt geselecteerd.

2 Wassen

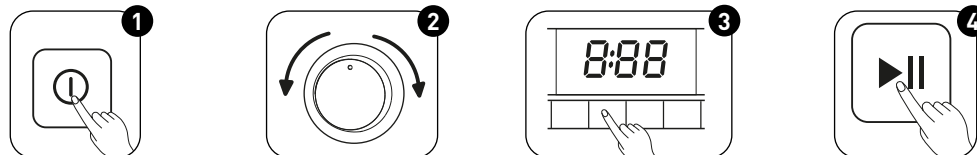

- 1 Zet het toestel aan
- 2 Selecteer het programma
- 3 Selecteer een functie of behoud de standaard instellingen
- 4 Druk op Start/Pauze om het programma te starten

3 Na het wassen

De zoemer weerklinkt en er verschijnt "End" op het weergavescherm.

Voor elke wasbeurt

- De omgevingstemperatuur moet liggen tussen 5-40°C. Indien de machine gebruikt wordt bij een temperatuur van minder dan 0°C kunnen de toevoerklep en het afvoersysteem beschadigd raken. Indien de machine in vorstomstandigheden is geïnstalleerd, moet ze naar een ruimte met normale omgevingstemperatuur worden verplaatst om ervoor te zorgen dat de watertoevoerslang en de afvoerslang kunnen ontdooien alvorens ze te gebruiken.
- Controleer de onderhoudsetiketten op uw kledij en de gebruiksinstructies voor het wasmiddel alvorens te beginnen wassen. Gebruik wasmiddel dat weinig of niet schuimt dat geschikt is voor wasmachines.

WAARSCHUWING!

- Was of droog geen artikelen die gereinigd, gewassen, gedrenkt of bevlekt zijn met brandbare of explosieve stoffen, zoals was, olie, verf, benzine, alcohol, kerosine en andere ontlambare materialen
- Het wassen van slechts enkele kledingstukken kan grote slingerbewegingen veroorzaken en het alarm doen afgaan als gevolg van onevenwicht. Daarom wordt gesuggereerd om één of twee extra stukken wasgoed toe te voegen aan de was zodat het centrifugeren gelijkmatiger kan verlopen

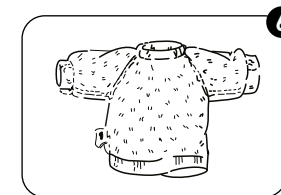
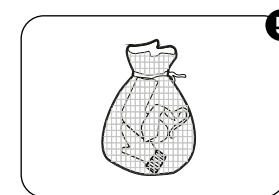
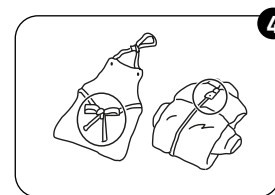
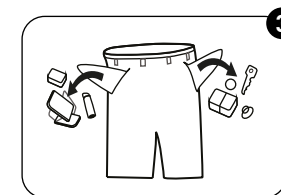
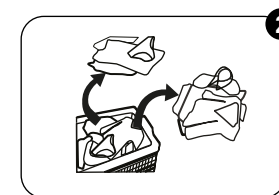
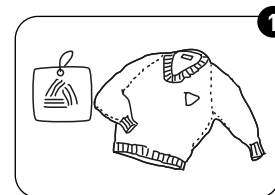



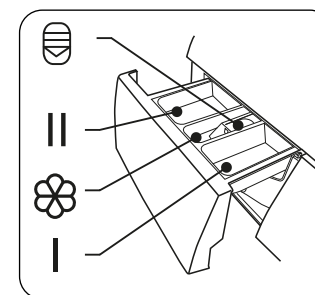













- 1 Controleer het onderhoudsetiket
- 2 Sorteert het wasgoed volgens kleur en soort textiel
- 3 Verwijder alle voorwerpen uit de zakken
- 4 Bind lange stoffen linten en riemen samen, sluit ritssluitingen en knopen
- 5 Stop kleine voorwerpen in een waszak
- 6 Draai stoffen die gemakkelijk pluizen of met lange haren binnenste buiten

Wasmiddeldispenser

- I Voorwas
- II Hoofdwas
- ☼ Wasverzachter
- 🗝️ Ontgrendelknop om de dispenser uit te trekken

OPGELET!

Er moet enkel wasmiddel worden toegevoegd in het "compartiment I" na het selecteren van de voorwasfunctie.

Programma	I	II	
 Synthetisch	<input type="radio"/>	<input checked="" type="radio"/>	<input type="radio"/>
 Gemengd	<input type="radio"/>	<input checked="" type="radio"/>	<input type="radio"/>
 Snel 45'	<input type="radio"/>	<input checked="" type="radio"/>	<input type="radio"/>
 Snel 15'		<input checked="" type="radio"/>	<input type="radio"/>
 Wol		<input checked="" type="radio"/>	<input type="radio"/>
 Anti-allergie	<input type="radio"/>	<input checked="" type="radio"/>	<input type="radio"/>
 Stoom	<input type="radio"/>	<input checked="" type="radio"/>	<input type="radio"/>
 Spoelen & Centrifugeren			<input type="radio"/>
 Enkel centrifugeren			
 Sportkleding	<input type="radio"/>	<input checked="" type="radio"/>	<input type="radio"/>
 20°C		<input checked="" type="radio"/>	<input type="radio"/>
 Jeans	<input type="radio"/>	<input checked="" type="radio"/>	<input type="radio"/>
 ECO 40-60		<input checked="" type="radio"/>	<input type="radio"/>
 Intensief		<input checked="" type="radio"/>	<input type="radio"/>
 Katoen	<input type="radio"/>	<input checked="" type="radio"/>	<input type="radio"/>

Betekent moet Betekent optioneel

Aanbevolen wasmiddel

Aanbevolen wasmiddel	Wascycli	Wastemperatuur	Soort wasgoed en textiel
Krachtig wasmiddel met bleekmiddelen en optische witmakers	Katoen ECO 40-60 Gemengd, Jeans, Intensief	20/30/40/60	Wit wasgoed vervaardigd uit katoen of linnen dat bestand is tegen kookwas
Kleurwasmiddel zonder bleekmiddelen en optische witmakers	Katoen, ECO 40-60, Gemengd, Jeans, Intensief	Cold/20/30/40	Gekleurd wasgoed vervaardigd uit katoen of linnen
Kleur- of mild wasmiddel zonder optische witmakers	Synthetisch	Cold/20/30/40	Gekleurd wasgoed vervaardigd uit vezels of synthetische materialen die gemakkelijk te reinigen zijn
Mild wasmiddel	Synthetisch	20/30	Delicate stoffen, zijde, viscose
Speciaal wolwasmiddel	Wol	20/30	Wol

OPMERKING

- Samengeklonterd of olieachtig wasmiddel of additief kan in een beetje water worden verdund alvorens het in de wasmiddeldispenser te gieten. Zo wordt vermeden dat de toevoer geblokkeerd raakt en het water overstroomt.
- Kies het geschikt type wasmiddel om maximale wasprestaties te bekomen en een minimum aan water en energie te verbruiken
- Om de beste reinigingsresultaten te bekomen is een juiste dosering van het wasmiddel belangrijk.
- Gebruik een kleinere hoeveelheid wasmiddel wanneer de trommel niet volledig gevuld is.
- Pas de hoeveelheid wasmiddel altijd aan de hardheid van het water aan. Wanneer uw leidingwater zacht is, gebruik dan minder wasmiddel.
- Doseer afhankelijk van hoe vuil uw wasgoed is. Hoe minder vuil de kledij, hoe minder wasmiddel er nodig is.
- Sterk geconcentreerd wasmiddel (compact wasmiddel) vereist een bijzonder nauwkeurige dosering.

De volgende symptomen zijn een teken van een te hoge dosering van de hoeveelheid wasmiddel:

- sterke schuimvorming
- slechte was- en centrifugeerresultaten

De volgende symptomen zijn een teken van een te lage dosering van de hoeveelheid wasmiddel:

- het wasgoed wordt grijs
- opbouw van kalkaanslag op de trommel, het verwarmingselement en/of het wasgoed

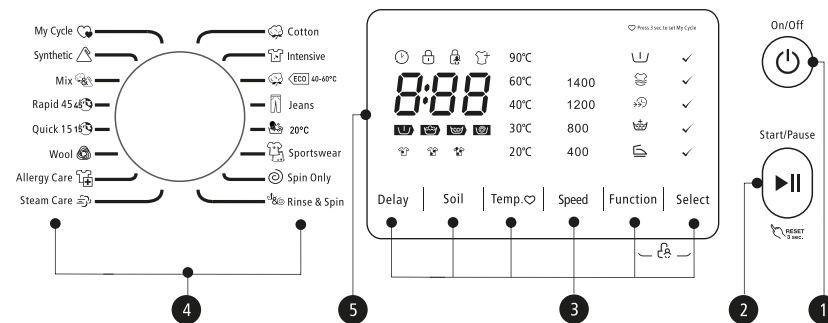
Bedieningspaneel**1 ON/OFF**

Zet het toestel aan en uit.

2 Start / Pauze

Start uw programma of zet het op pauze.

3 Optie

Hiermee kunt u bijkomende functies selecteren en deze zullen oplichten wanneer ze geselecteerd worden.

4 Programma's

Beschikbaar afhankelijk van het type wasgoed.

5 Weergavescherm

Op het weergavescherm staan de instellingen, de geschatte resterende tijd, de opties en de statusberichten.

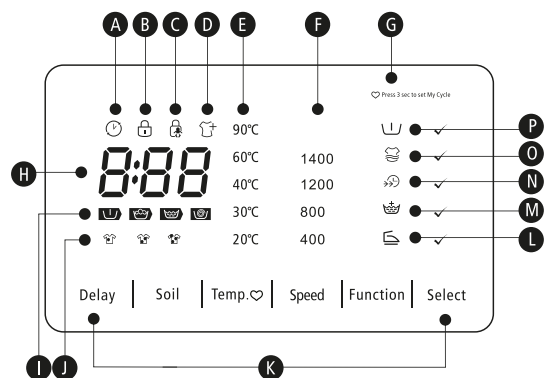

A Uitgesteld starten

B Deurvergrendeling

C Kinderslot

D Opnieuw laden

E Temp.

F Snelheid

G Mijn cyclus

H	Duur van de wasbeurt	Duur Uitgesteld starten	Fout E20	Einde Eind
	1:25	2h		

I Voorwassen-Wassen-Spoelen-Centrifugeren

J Vuilgraad

K Opties

L Anti-Kreuk

M Extra spoelen

N Snelwas

O Extra was







P Voorwas

Programma's

Programma	Lading (kg)			Weergave tijd
MACHINECAPACITEIT >	7,0	8,0	12,0	7,0/8,0/12,0
Katoen	7,0	8,0	12,0	3:39
Intensief	7,0	8,0	12,0	3:48
ECO 40-60°C	7,0	8,0	12,0	3:13/3:32/3:56
Jeans	7,0	8,0	12,0	1:35
20°C	3,5	4,0	6,0	1:01
Sportkleding	3,5	4,0	6,0	0:45
Enkel centrifugeren	7,0	8,0	12,0	0:12
Spoelen & Centrifugeren	7,0	8,0	12,0	0:20
Stoom	7,0	8,0	12,0	1:47
Anti-allergie	3,5	4,0	6,0	2:09
Wol	2,0	2,0	2,0	1:07
Snel 15'	2,0	2,0	2,0	0:15
Snel 45'	2,0	2,0	2,0	0:45
Gemengd	7,0	8,0	6,0	1:20
Synthetisch	3,5	4,0	6,0	3:17

- De bovenstaande gegevens worden louter als referentie gegeven en de gegevens kunnen wijzigen afhankelijk van verschillende effectieve gebruiksomstandigheden.
- De opgegeven waarden voor andere programma's dan het ECO 40-60 programma zijn louter indicatief.
- Wat betreft Verordening (EU) nr. 1061/2010,
De EU energie-efficiëntieklasse is: A+++
Energietestprogramma: Intensive 60/40°C; Snelheid: De hoogste snelheid;
Andere dan de standaard
Halve lading voor een machine voor 7,0/8,0/12,0 kg: 3,5/4,0/6,0 kg.
- Wat betreft de Verordening (U) 2019/2023,
De EU energie-efficiëntieklasse is: B
Energietestprogramma: ECO 40-60. Andere dan de standaard.
Halve lading voor een machine voor 7,0/8,0/12,0 kg: 3,5/4,0/6,0 kg.
Kwartlading voor een machine voor 7,0/8,0/12,0 kg: 2,0/2,0/3,0 kg.

Programma's

Cyclus	Nominale capaciteit in kg	Cyclustijd in uren en minuten	Energieverbruik in kWh/werkcyclus	Waterverbruik in liter/werkcyclus	Hoogste temperatuur °C	Resterend vocht in %/centrifugeer-snelheid
 20°C	3,5	1:01	0,100	45	20	65% / 1000
 Katoen (60°C)	7,0	3:44	1,392	65	60	53% / 1400
 Intensief	7,0	3:48	1,000	68	40	70% / 800
 Gemengd	7,0	1:20	0,710	60	40	70% / 800
 Snel 15'	2,0	0:15	0,030	40	Cold	75% / 800
	7,0	-	0,775	54	36	53% / 1400
	3,5	-	0,47	44	34	53% / 1400
	2,0	-	0,2	35	21	53% / 1400

- De bovenstaande gegevens worden louter als referentie gegeven en de gegevens kunnen wijzigen afhankelijk van verschillende effectieve gebruiksomstandigheden.
- De opgegeven waarden voor andere programma's dan het ECO 40-60 programma zijn louter indicatief.
- Wat betreft Verordening (EU) nr. 1061/2010,
De EU energie-efficiëntieklasse is: A+++
Energietestprogramma: Intensive 60/40°C; Snelheid: De hoogste snelheid;
Andere dan de standaard
Halve lading voor een machine voor 7,0 kg: 3,5 kg.
- Wat betreft de Verordening (U) 2019/2023,
De EU energie-efficiëntieklasse is: B
Energietestprogramma: ECO 40-60. Andere dan de standaard.
Halve lading voor een machine voor 7,0 kg: 3,5 kg.
Kwartlading voor een machine voor 7,0 kg: 2,0 kg.

Programma's

Cyclus 8kg	Nominale capaciteit in kg	Cyclusduur in uren en minuten	Energieverbruik in kWh/werkcyclus	Waterverbruik in liter//werkcyclus	Hoogste temperatuur °C	Resterend vocht in %/centrifugeer- snelheid
20°C	4,0	1:01	0,15	50	20	65% / 1000
Katoen (60°C)	8,0	3:44	1,498	70	60	53% / 1400
Intensief	8,0	3:48	1,100	70	40	70% / 800
Gemengd	8,0	1:20	0,75	65	40	70% / 800
Snel 15'	2,0	0:15	0,030	40	Cold	75% / 800
	8,0	-	0,857	59	34	53% / 1400
40-60°C	4,0	-	0,504	46	29	53% / 1400
	2,0	-	0,24	37	21	53% / 1400

- De bovenstaande gegevens worden louter als referentie gegeven en de gegevens kunnen wijzigen afhankelijk van verschillende effectieve gebruiksomstandigheden.
- De opgegeven waarden voor andere programma's dan het ECO 40-60 programma zijn louter indicatief.
- Wat betreft Verordening (EU) nr. 1061/2010, De EU energie-efficiëntieklasse is: A+++
Energietestprogramma: Intensive 60/40°C; Snelheid: De hoogste snelheid;
Andere dan de standaard
Halve lading voor een machine voor 8,0 kg: 4,0 kg.
- Wat betreft de Verordening (U) 2019/2023, De EU energie-efficiëntieklasse is: B
Energietestprogramma: ECO 40-60. Andere dan de standaard.
Halve lading voor een machine voor 8,0 kg: 4,0 kg.
Kwartlading voor een machine voor 8,0 kg: 2,0 kg.

Programma's

Cyclus 12kg	Nominale capaciteit in kg	Cyclusduur in uren en minuten	Energieverbruik in kWh/werkcyclus	Waterverbruik in liter//werkcyclus	Hoogste temperatuur °C	Resterend vocht in %/centrifugeer- snelheid
20°C	6,0	1:01	0,206	58	20	65% / 1000
Katoen (60°C)	12,0	3:44	1,919	99	60	53% / 1400
Intensief	12,0	3:48	1,417	99	40	70% / 800
Gemengd	12,0	1:20	0,988	99	40	70% / 800
Snel 15'	2,0	0:15	0,030	40	15	75% / 800
	12,0	-	1,345	87	40	53% / 1400
40-60°C	6,0	-	0,858	62	38	53% / 1400
	3,0	-	0,242	42	20	53% / 1400

- De bovenstaande gegevens worden louter als referentie gegeven en de gegevens kunnen wijzigen afhankelijk van verschillende effectieve gebruiksomstandigheden.
- De opgegeven waarden voor andere programma's dan het ECO 40-60 programma zijn louter indicatief.
- Wat betreft Verordening (EU) nr. 1019/2023, De EU energie-efficiëntieklasse is: B
Energietestprogramma: ECO 60/40°C; Andere dan de standaard.
Halve lading voor een machine voor 12,0 kg: 6,0 kg.
Kwartlading voor een machine voor 12,0 kg: 3,0 kg.

- De hoogste temperatuur die door het wasgoed tijdens de wascyclus wordt bereikt gedurende minstens 5 minuten.
- Resterend vocht na de wascyclus uitgedrukt in percentage waterinhoud en de centrifugeersnelheid bij welke dit werd behaald.
- Met het programma ECO 40-60 kan normaal vervuild katoenen wasgoed worden gereinigd dat samen in dezelfde cyclus wasbaar is op 40°C of 60°C. Dit programma wordt gebruikt om te beoordelen of de Verordening (EU) nr. 2019/2023 is nageleefd.

De meest efficiënte programma's in termen van energieverbruik zijn over het algemeen diegene die werken bij lagere temperaturen en gedurende langere periodes.

De huishoudelijke wasmachine laden tot de capaciteit die aangegeven is voor de respectieve programma's zal bijdragen aan energie- en waterbesparingen.

Het lawaai en het resterende vochtgehalte worden beïnvloed door de centrifugeersnelheid: hoe hoger de centrifugeersnelheid tijdens de centrifugeerfase, hoe hoger het lawaai en hoe lager het resterende vochtgehalte

OPGELET!

Indien er een stroomonderbreking is terwijl de machine draait, is er een speciaal geheugen dat het geselecteerde programma opslaat. De machine zal het programma verder zetten eenmaal de stroomvoorziening is hersteld.

Programma's

Er zijn programma's beschikbaar afhankelijk van het type wasgoed.

Programma's



Synthetisch

Wassen van synthetische artikelen, bijvoorbeeld: hemden, jassen, gemengde kledij. Voor het wassen van gebreide stoffen zal de hoeveelheid wasmiddel afnemen als gevolg van de losse vezelstructuur en het feit dat gemakkelijk bellen worden gevormd. Slijtvaste stoffen, hittebestendige stoffen vervaardigd uit katoen of linnen.



Gemengd

Gemengde lading bestaand uit stoffen vervaardigd uit katoen of synthetisch materiaal.



Snel 45'

Dit programma is geschikt voor het wassen van zeer vuile kledij, bespaart meer energie en wastijd



Snel 15'

Extra kort programma geschikt voor licht vuile kledij en kleine hoeveelheden wasgoed.



Wol

Hand- of machinewasbare wollen stoffen of stoffen met veel wol. Bijzonder mild wasprogramma om krimpen te voorkomen, langere programmapauzes (stoffen rusting in wasvloeistof).



Anti-allergie

De wasmachine kan op efficiënte wijze enkele allergenen doden en een anti-allergeen effect behalen door 60°C aan te passen naar een hogere temperatuur voor sterilisatie.



Stoom

Steam Care wordt gebruikt voor dagelijkse wasbeurten van katoen en synthetische materialen. De stoom kan diep in de vezel doordringen waardoor bacteriën en microben op efficiënte wijze worden geëlimineerd, geurtjes worden voorkomen en uw gezondheid wordt beschermd.



Spoelen & Centrifugeren

Extra spoelen met centrifugeren.



Enkel centrifugeren

Extra centrifugeren met selecteerbare centrifugeersnelheid.



Sportkleding

Voor het wassen van sportkledij.



20°C

Standaard 20°C, kan koud water kiezen.



Jeans

Speciaal voor jeans.



ECO 40-60°C

Standaard 40°C, niet selecteerbaar, geschikt voor het wassen van wasgoed op een temperatuur van 40°C tot 60°C.



Intensief



















































































Om de waseffecten te verhogen, wordt de wastijd verlengd.



Katoen

Slijtagevaste stoffen, hittebestendige stoffen vervaardigd uit katoen of linnen.

Option

Cyclus	Standaard Temp.(°C)	Standaard centrifugeersnelheid in tpm	Extra functies
Wascycli		1400	
 Synthetisch	40	1200	      
 Gemengd	40	800	      
 Snel 45'	40	800	    
 Snel 15'	Cold	800	
 Wol	40	800	   
 Anti-allergie	60	800	     
 Stoom	40	800	      
 Spoelen & Centrifugeren	-	800	   
 Enkel centrifugeren	-	800	 
 Sportkleding	20	800	    
 20°C	20°C	800	   
 Jeans	30	800	     
 ECO 40-60	-	1400	
 Intensief	40	800	
 Katoen	40	1400	      

OMMERKING

- Voor de maximale centrifugeersnelheid, programmatijd en andere details van het programma ECO 40-60 verwijzen we naar de inhoud van de pagina Productfiche.
- De tabel toont welke cyclus welke aanpassingsopties biedt.

Temp.

Temp.

Indien nodig kan de wastemperatuur worden aangepast door op de temperatuurknop te drukken in de volgende stappen: Cold - 20°C - 30°C - 40°C - 60°C - 90°C.

Delay

Uitgesteld starten

De Delay-functie instellen:

- 1 Selecteer een programma;
- 2 Druk op de knop Delay om de tijd te kiezen (de tijd voor uitgestelde start is 0- 24 uur);
- 3 Druk [Start/Pause] om de functie uitgesteld starten te beginnen



Kies het programma



De tijd instellen



Start

De functie Delay annuleren:

Druk op de knop [Delay] tot er 0 uur op het weergavescherm verschijnt. Deze knop moet worden ingedrukt alvorens het programma te starten. Indien het programma reeds gestart is, moet het programma worden uitgeschakeld om een nieuw in te stellen.

Soil

Vlekken

De wastijd zal afnemen of toenemen nadat u deze geselecteerd hebt.

**Voorwas**

De voorwasfunctie biedt een extra wasbeurt vóór de hoofdwas en is geschikt voor het wegwassen van het stof dat van de kledij naar de oppervlakte stijgt; U moet wasmiddel toevoegen in het Vakje (I) wanneer deze functie wordt geselecteerd.

**Extra was**

Dit programma kan gekozen worden voor zeer vuile kledij. Wanneer het wordt geselecteerd, wordt de wastijd en -intensiteit verhoogd om het waseffect te verhogen.

**Snelwas**

Met deze functie kan de wastijd worden verminderd.

**Extra spoelen**

Het wasgoed zal een extra spoelbeurt ondergaan wanneer dit programma wordt geselecteerd.

**Mijn cyclus**

Om het frequent gebruikte programma in het geheugen op te slaan.

Druk 3 seconden voor het begin van het wassen op [Temp.] na het kiezen van het programma en het instellen van de opties. De standaard instelling is Cotton.

**Anti-kreuk**

De antikreukfunctie kan worden gebruikt kreuken in de kledij te verminderen.

Start/Pause
Houd 3 sec. in
Pauze**Opnieuw laden**

Deze handling kan worden uitgevoerd tijdens het wasproces. Wanneer de trommel nog draait en er een grote hoeveelheid water met een hoge temperatuur in de trommel zit.

De staat is onveilig en de deur kan niet worden geopend door veel kracht te gebruiken.

Druk 3 seconden lang op de knop [Start/Pause] om te herladen en het toevoegen van kledij tijdens de functie. Volg de onderstaande stappen:

- 1 Wacht tot de trommel stopt met draaien.
- 2 Het deurslot wordt ontgrendeld.
- 3 Sluit de deur wanneer de kledij herladen is en druk op de knop [Start/Pause].



Druk 3 seconden lang op [Start/Pause]



Herlaad de kledij



Start

**Kinderslot**

Om te vermijden dat kinderen het per ongeluk bedienen.

Druk 3 seconden lang op de knoppen [Function] en [Select] tot de zoemer weerklinkt.

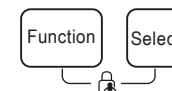

OPGELET!

Wanneer de kinderbeveiliging is geactiveerd en het programma start, zal de indicator van de kinderbeveiliging worden geactiveerd en wordt de resterende CL en resterende tijd op het display om beurt weergegeven in 0,5 seconden.

Wanneer op de andere knoppen wordt gedrukt, knippert de indicator voor de kinderbeveiliging gedurende 3 seconden, wanneer het programma eindigt, wisselen CL en END gedurende 10 seconden, vervolgens knipperen de lampjes van de kinderbeveiliging gedurende 3 seconden

- Het volstaat op de twee knoppen te drukken en deze ingedrukt te houden om de kinderbeveiliging te ontgrendelen, zelfs in geval van stroomonderbreking, het uitzetten van het toestel en na het einde van het programma
- Met de knop Child Lock worden alle knoppen vergrendeld, behalve de Power-knop en de Child Lock-knop
- Gelieve de kinderbeveiliging uit te schakelen alvorens een programma te selecteren en te beginnen wassen

Temp.

Temp.

Druk op de knop om de temperatuur in te stellen (Cold, 20°C, 30°C, 40°C, 60°C, 90°C)

Function

Kies optie

Selecteer de functie Pre Wash, Extra Rinse, Extra Wash, Night Wash of Anti-crease.

Select

Bevestig optie

Bevestig de selectie van de functie Pre Wash, Extra Rinse, Speed Wash, Night Wash of Anti-crease functie

Speed

Speed

Druk op de knop om de snelheid te wijzigen
1400: 0-400-800-1200-1400

Reiniging en onderhoud**WAARSCHUWING**

Trek altijd de stekker van het toestel uit het stopcontact en draai de waterkraan dicht alvorens te reinigen en te onderhouden.

Reinigen van de kast

Een degelijk onderhoud van de wasmachine kan de levensduur ervan verlengen. Waar nodig kan het oppervlak gereinigd worden met verdunde, niet-schurende neutrale reinigingsmiddelen. Wanneer er water uit de machine is gestroomd, gebruik dan een doek om het onmiddellijk weg te vegen. Gebruik nooit scherpe voorwerpen om het toestel te reinigen.

**OPGELET!**

Gebruik nooit schurende of bijtende middelen, mierenzuur of verdunde oplossingen of gelijkaardige substanties, zoals alcohol of scheikundige producten.

De trommel reinigen

Roestvlekken die in de trommel zijn achtergebleven door metalen voorwerpen moeten onmiddellijk worden verwijderd met schoonmaakmiddelen die geen chloor bevatten. Gebruik nooit staalwol om de trommel te reinigen

OPMERKING

Houd wasgoed uit de buurt van de machine terwijl de trommel wordt gereinigd

De deurdichting en het glas reinigen

Veeg het glas en de dichting na elke wasbeurt af om pluizen en vlekken te verwijderen. Wanneer pluizen zich ophopen, kan dit lekken veroorzaken. Verwijder eventuele muntstukken, knopen en andere voorwerpen uit de dichting na elke wasbeurt.

Reinig de deurdichting en het glas elke maand om de normale werking van het toestel te waarborgen.

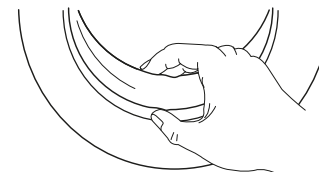

De toevoerfilter reinigen

OPMERKING

Een verminderde waterstroom is een teken dat de filter gereinigd moet worden.

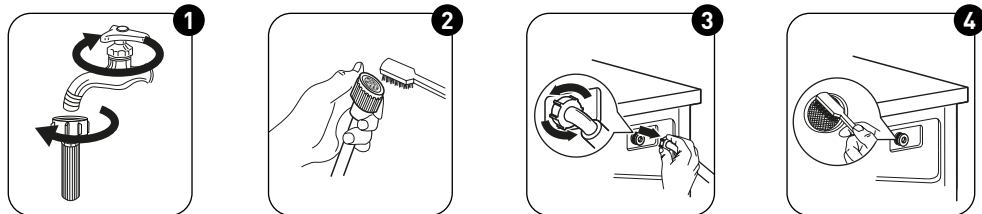

- ❶ Draai de kraan dicht en verwijder de watertoevoerslang.
- ❷ Reinig de filter met een borsteltje.
- ❸ Schroef de watertoevoerslang los van de achterkant van de machine. Verwijder de filter met een langneustang.
- ❹ Gebruik een borsteltje om de filter te reinigen.
- ❺ Plaats de filter opnieuw in de watertoevoer en sluit de watertoevoerslang opnieuw aan.
- ❻ Reinig de toevoerfilter om de 3 maanden om de normale werking van het toestel te waarborgen.

Reinig de wasmiddeldispenser

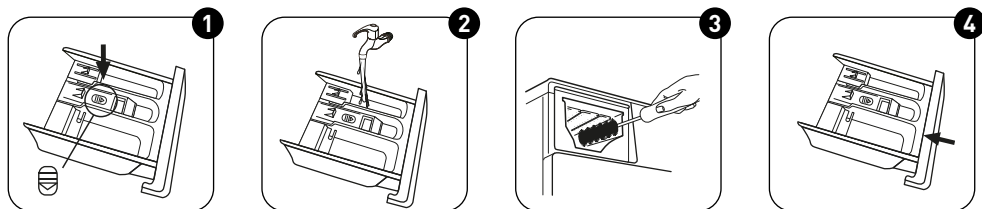

- ❶ Druk op de ontgrendelknop en verwijder de dispenserlade.
- ❷ Reinig de dispenserlade en het deksel van de waterverzachter onder stromend water.
- ❸ Reinig de nis met een zachte borstel.
- ❹ Plaats de dispenserlade opnieuw op zijn plaats.

OPMERKING

- Gebruik geen schurende of bijtende middelen om kunststof onderdelen te reinigen.
- Reinig de wasmiddeldispenser om de 3 maanden om de normale werking van het toestel te waarborgen.

De afvoerpompfilter reinigen

WAARSCHUWING!

- Opgelet voor het hete water!
- Laat de wasmiddeloplossing afkoelen.
- Trek de stekker van de machine uit het stopcontact om elektrische schokken te vermijden voor het wassen.
- De afvoerpompfilter kan de pluizen en kleine vreemde voorwerpen uit de wasmachine filteren.
- Reinig regelmatig de filter om de normale werking van de wasmachine te waarborgen.

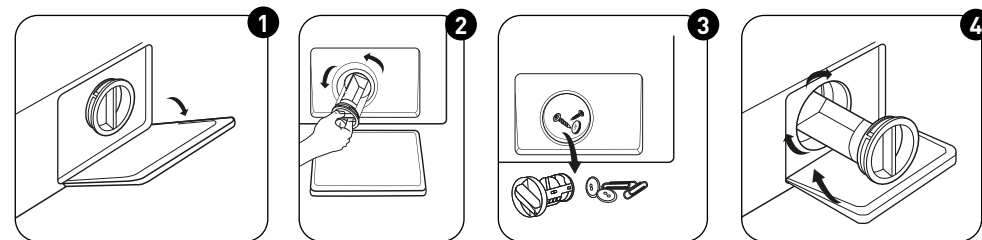

- ❶ Open het onderste deksel
- ❷ Open de filter door deze in tegenwijzerzin te draaien
- ❸ Verwijder vreemde voorwerpen
- ❹ Sluit het onderste deksel

OPGELET!

- Zorg ervoor dat het deksel van de klep en de noodafvoerslang opnieuw naar behoren zijn geïnstalleerd. De dekselplaten moeten precies overeenstemmen met de openingsplaten anders kan er water lekken.
- Sommige machines hebben geen noodafvoerslang, dus kunnen stappen 2 en 3 worden overgeslagen. Draai het onderste deksel om water in het bassin te laten lopen
- Wanneer het toestel gebruikt wordt en afhankelijk van het geselecteerde programma is het mogelijk dat er heet water in de pomp aanwezig is. Verwijder het deksel van de pomp nooit tijdens een wascyclus. Wacht altijd tot het toestel de cyclus heeft voltooid en leeg is. Wanneer het deksel opnieuw wordt geïnstalleerd, zorg er dan voor dat het veilig opnieuw bevestigd is.

Probleemoplossgids

Wanneer er een probleem is met het toestel, controleer dan of u het niet kan oplossen met de onderstaande tabellen. Wanneer het probleem aanhoudt, contacteer dan de klantendienst.

Omschrijving	Mogelijke oorzaak	Oplossing
Het toestel start niet	De deur is niet goed gesloten Er zitten kleren vast.	Sluit de deur goed en start opnieuw. Controleer het wasgoed.
De deur kan niet worden geopend	De veiligheidsbescherming is geactiveerd.	Schakel de stroom uit en start opnieuw. Controleer en bevestig de watertoevoerslang. Controleer en reinig de afvoerslang.
Er lekt water	De aansluitingen zijn niet voldoende vastgedraaid.	Reinig en wrijf de wasmiddeldispenser droog.
Er zitten resten wasmiddel in de wasmiddeldispenser	Het wasmiddel is vochtig en/of geklonterd.	Schakel de stroom uit en controleer of de hoofdplug goed is aangesloten.
De indicator of het weergavescherm werkt niet	PC-bord of harnas hebben verbingsproblemen.	Controleer of de bevestigingsbouten verwijderd zijn. Zorg ervoor dat het toestel op een stevige en vlakke vloer is geïnstalleerd.
Abnormaal geluid	Bevestigingsschroeven zitten nog altijd op hun plaats. De vloer is niet stevig of waterpas.	

Foutcodes

Omschrijving	Mogelijke oorzaak	Oplossing
E30	De deur is niet goed gesloten.	Sluit de deur naar behoren en herstart.
E10	Probleem met het injecteren van water tijdens de wascyclus.	Controleer of de waterdruk voldoende hoog is. Maak de waterslang recht. Reinig de toevoerklefilter.
E21	Waterafvoer overtijd	Controleer de afvoerslang op blokkeringen.
E12	Wateroverstroom	Herstart het toestel.
EXX	Andere	Herstart het toestel. Neem contact op met de klantendienst wanneer het probleem aanhoudt

Klantendienst

Er zijn minimaal 10 jaar reserveonderdelen beschikbaar voor uw toestel. Mocht u vragen hebben, neem dan contact op met de klantendienst op:

WAARSCHUWING!**Risico op elektrische schokken**

- Probeer nooit een toestel te herstellen dat defect of vermoedelijk defect is. Hierdoor kunt u uw eigen leven of dat van toekomstige gebruikers in gevaar brengen. Enkel bevoegde specialisten mogen deze herstelwerkzaamheden uitvoeren.
- In geval van ongepaste herstelling vervalt de garantie en zal daarop volgende schade niet worden erkend!

Transport**BELANGRIJKE STAPPEN BIJ HET VERPLAATSEN VAN HET TOESTEL**

- Trek de stekker van het toestel uit het stopcontact en draai de watertoevoerkraan dicht.
- Controleer of de deur en de wasmiddeldispenser goed gesloten zijn.
- Verwijder de watertoevoerslang en de afvoerslang van de behuizing.
- Verwijder de waterafvoer volledig van het toestel (zie "Onderhoud Reiniging van de afvoerpompfilter")
- Belangrijk: Plaats de 4 transportbouten opnieuw op de achterkant van het toestel.
- Dit toestel is zwaar. Transporteer voorzichtig. Houdt geen uitstekende onderdelen van de machine vast tijdens het optillen. De deur van de machine mag niet gebruikt worden als handgreep.

¡Gracias!

Gracias por elegir este producto VALBERG. Seleccionados, probados y recomendados por ELECTRO DEPOT, los productos de la marca VALBERG son fáciles de usar, fiables y de un acabado impecable. Gracias a este aparato, puede estar seguro de que cada uso le proporcionará satisfacción.

Bienvenido a ELECTRO DEPOT.

A Vista previa del aparato

Descripción del aparato

B Uso del aparato

Instalación
Funcionamiento

C Información útil

Limpieza y mantenimiento
Solución de problemas
Atención al cliente

Descripción del aparato

- ❶ Manguera de suministro de agua
- ❷ Dispensador de detergente
- ❸ Puerta
- ❹ Cubierta superior
- ❺ Panel de control
- ❻ Cable de alimentación eléctrica
- ❼ Tambor
- ❽ Tapa de mantenimiento
- ❾ Tubo de drenaje
- ❿ 4 tapas
- ⓫ 1 tubo de suministro de agua fría

NOTA

La imagen del producto solo es con fines ilustrativos. Consulte el producto real como referencia.

Instalación

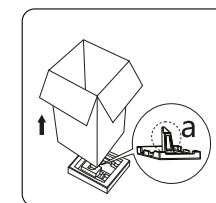
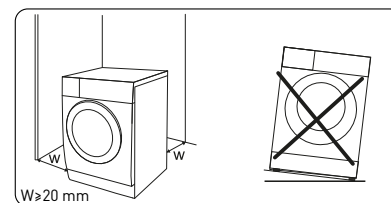

Zona de instalación

¡ADVERTENCIA!

- ¡La estabilidad es importante para evitar que el producto se desplace de su sitio! Asegúrese de que la máquina esté nivelada y en posición estable.
- Asegúrese de que el producto no pise el cable de alimentación.
- Asegúrese de mantener las distancias mínimas desde las paredes, como se muestra en la imagen.

Antes de instalar la máquina, debe seleccionarse la ubicación de la siguiente manera:

- ❶ Superficie rígida, seca y plana
- ❷ Evite la luz directa del sol
- ❸ Debe haber ventilación suficiente
- ❹ La temperatura del sitio debe ser por encima de 0 °C
- ❺ Debe estar alejada de fuentes de calor como aparatos de combustión de carbón o gas.

Desembalaje de la lavadora**¡ADVERTENCIA!**

- El material de embalaje (por ejemplo, el papel transparente o la espuma de poliestireno) pueden ser peligrosos para los niños.
- ¡Hay peligro de asfixia! Mantenga todo el embalaje totalmente alejado de los niños.

- 1 Quite la caja de cartón y el embalaje de espuma de poliestireno.
- 2 Levante la lavadora y quite el embalaje de la base. Asegúrese de que el pequeño triángulo de espuma (a) se quite junto con el embalaje inferior. De no ser así, tumbe la unidad de lado y quítelo manualmente.
- 3 Quite la cinta adhesiva que fija el cable de suministro y el tubo de drenaje.
- 4 Quite el tubo de entrada del tambor.

Quite los pernos de transporte**¡ADVERTENCIA!**

Debe quitar los pernos de transporte de la parte trasera antes de utilizar el producto.



- 1 Afloje los 4 pernos de transporte con una llave inglesa.
- 2 Quite los pernos, incluyendo las partes de goma, y guárdelos para un uso futuro.
- 3 Cierre los orificios utilizando las tapas.

Nivelación de la lavadora**¡ADVERTENCIA!**

Las tuercas de fijación de los cuatro pies deben apretarse firmemente contra el alojamiento.



- 1 Afloje la tuerca de fijación.
- 2 Gire el pie hasta que llegue hasta el suelo.
- 3 Ajuste las patas y bloquee las tuercas con una llave inglesa. Asegúrese de que la máquina esté nivelada y en posición firme.

Conecte el tubo de suministro de agua**¡ADVERTENCIA!**

Para evitar fugas o daños por agua, siga las instrucciones de este capítulo.

- No retuerza, aplaste ni modifique el tubo de entrada de agua.

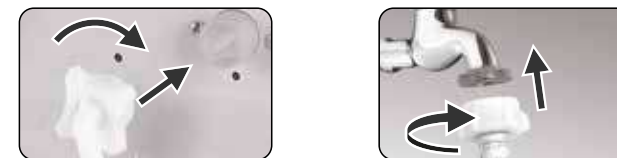

Conecte el tubo de suministro de agua a la válvula de entrada de agua y a una toma de agua fría, tal y como se indica.

NOTA

Haga la conexión manualmente, sin herramientas. Compruebe que las conexiones estén apretadas.

Tubo de drenaje**¡ADVERTENCIA!**

- No retuerza ni dilate el tubo de drenaje.
- Coloque el tubo de drenaje correctamente. De lo contrario, pueden producirse daños por la fuga de agua.

Hay dos formas de colocar el extremo del tubo de drenaje:

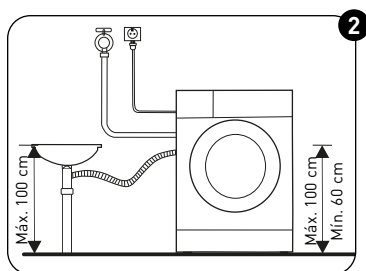
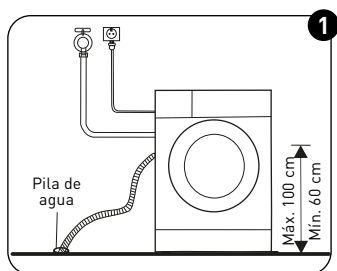

- 1 Póngalo en la pila de agua.
- 2 Conéctelo al tubo del ramal de drenaje de la pila.

Funcionamiento**Inicio rápido****¡PRECAUCIÓN!**

- Antes del lavado, asegúrese de que la lavadora esté bien instalada.
- Su aparato fue revisado a fondo antes de salir de la fábrica. Para quitar el agua residual y neutralizar posibles olores, se recomienda limpiar el aparato antes del primer uso. Para ello, ponga en marcha el programa de algodón a 90 °C sin ropa ni detergente.

CALIBRACIÓN

Se recomienda calibrar la lavadora para que funcione con el mejor rendimiento. El aparato puede detectar la cantidad de ropa introducida. Esta función optimiza el rendimiento del producto reduciendo al mínimo el consumo de energía y agua, lo que le permite ahorrar tiempo y dinero. Por este motivo se recomienda calidad el aparato para aprovechar al máximo su rendimiento.

- 2 Quite todos los accesorios del tambor y cierre la puerta.
- 2 Inserte el enchufe a la toma de red.
- 2 Encienda la lavadora y pulse "Delay" (inicio diferido) y "Temp." simultáneamente durante 10 segundos, hasta que aparezca "t19".
- 2 Pulse [▶||] para encender el aparato y espere a que aparezca "****".

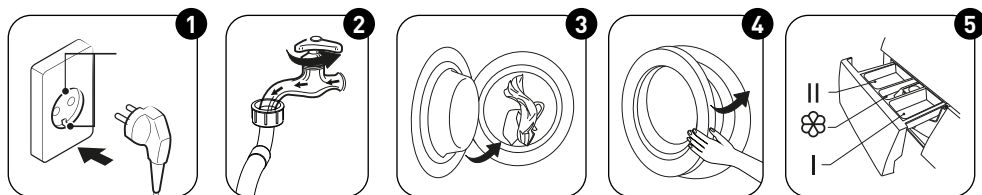
1 Antes del lavado

- 1 Enchufar
- 2 Abrir la toma de agua
- 3 Cargar
- 4 Cerrar la puerta
- 5 Añadir detergente

NOTA

Debe añadirse detergente al compartimento I si se selecciona la función de prelavado.

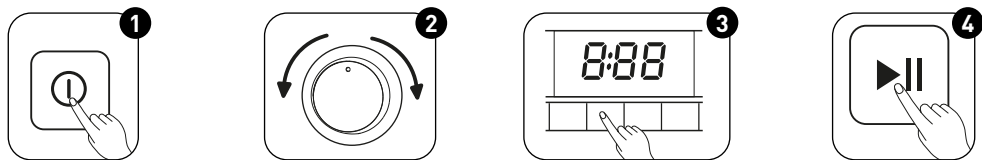
2 Lavado

- 1 Encender
- 2 Seleccionar el programa
- 3 Elegir el modo de funcionamiento o dejar los ajustes predeterminados
- 4 Pulsar Inicio/Pausa para iniciar el programa

3 Después del lavado

Suena el avisador y aparece "End" (Fin) en la pantalla.

Antes de cada lavado

- La temperatura ambiental de la lavadora debe ser de 5-40 °C. Si se utilizara por debajo de los 0 °C, la válvula de entrada y el sistema de drenaje podrían dañarse. Si la máquina se ha instalado en una zona a temperaturas bajo cero, debe cambiarse a una temperatura ambiental normal para asegurarse de que el tubo de suministro de agua y el tubo de drenaje se descongelan antes de utilizarse.
- Consulte las etiquetas de lavado de su ropa y las instrucciones de uso del detergente antes del lavado. Utilice detergente sin espuma o con poca espuma adecuado para lavadoras.

¡ADVERTENCIA!

- No lave ni seque prendas que hayan sido limpiadas, lavadas, remojadas o frotadas con sustancias combustibles o explosivas como cera, aceite, pintura, gasolina, alcohol, queroseno u otros materiales inflamables.
- El lavado de prendas aisladas puede crear fácilmente una gran excentricidad y disparar la alarma debido al desequilibrio. Por lo tanto, se recomienda añadir una o dos prendas más al lavado para que el giro sea suave.

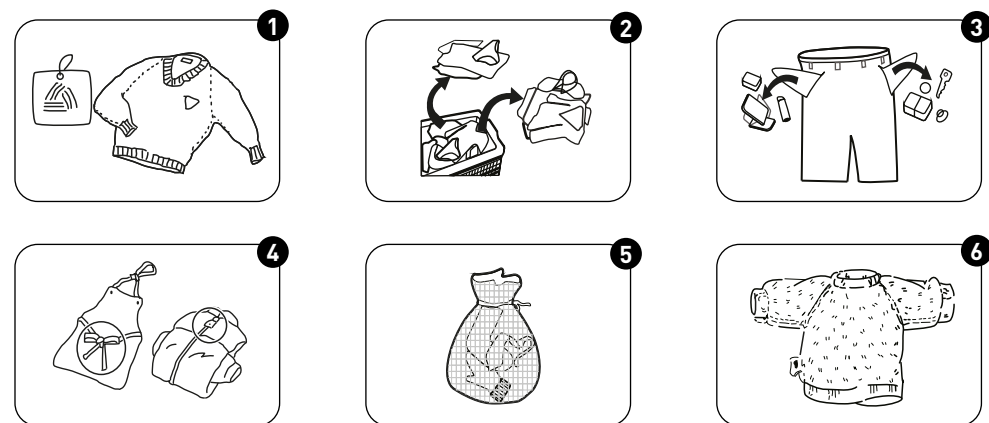

- ❶ Mire la etiqueta de lavado
- ❷ Divida la ropa por color y tipo de tejido
- ❸ Vacíe los bolsillos
- ❹ Ate las correas largas y los cinturones, cierre las cremalleras y los botones
- ❺ Ponga las prendas pequeñas en una redcilla de lavado
- ❻ Vuelva del revés las prendas que puedan deshilacharse y de pelo alto

Dispensador de detergente

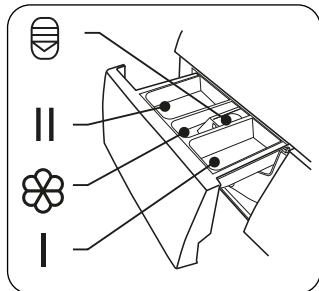

- I Prelavado
- II Lavado principal
- ☼ Suavizante
- 🍷 Botón de extracción para sacar el dispensador

¡PRECAUCIÓN!

En el "Compartimento I" solo se añade detergente si se selecciona la opción de prelavado.

Programa	I	II	☼
Sintéticos	<input type="radio"/>	<input checked="" type="radio"/>	<input type="radio"/>
Mixto	<input type="radio"/>	<input checked="" type="radio"/>	<input type="radio"/>
Rápido 45'	<input type="radio"/>	<input checked="" type="radio"/>	<input type="radio"/>
Rápido 15'		<input checked="" type="radio"/>	<input type="radio"/>
Lana		<input checked="" type="radio"/>	<input type="radio"/>
Antialergias	<input type="radio"/>	<input checked="" type="radio"/>	<input type="radio"/>
Vapor	<input type="radio"/>	<input checked="" type="radio"/>	<input type="radio"/>
Aclarado y centrifugado			<input type="radio"/>
Solo centrifugado			
Ropa de deporte	<input type="radio"/>	<input checked="" type="radio"/>	<input type="radio"/>
20°C		<input checked="" type="radio"/>	<input type="radio"/>
Vaqueros	<input type="radio"/>	<input checked="" type="radio"/>	<input type="radio"/>
ECO 40-60°C		<input checked="" type="radio"/>	<input type="radio"/>
Intensivo		<input checked="" type="radio"/>	<input type="radio"/>
Algodón	<input type="radio"/>	<input checked="" type="radio"/>	<input type="radio"/>

● Obligatorio ○ Opcional

Recomendaciones de detergente

Detergente recomendado	Ciclos de lavado	Temp. de lavado	Tipo de ropa y tejido
Detergente intenso con blanqueadores y abrillantadores ópticos	Algodón ECO 40-60 Mixto, Vaqueros, Intensivo	20 / 30 / 40 / 60	Ropa blanca de lino o algodón a resistente al hervido
Detergente para color sin blanqueadores ni abrillantadores ópticos	Algodón, ECO 40-60, Mixto, Vaqueros, Intensivo	Cold / 20 / 30 / 40	Ropa de color de lino o algodón
Detergente para color o suave sin abrillantadores ópticos	Sintéticos	Cold / 20 / 30 / 40	Ropa de color hecha de tejidos fáciles de cuidar o materiales sintéticos
Detergente suave	Sintéticos	20 / 30	Tejidos delicados, seda, viscosa
Detergente especial para lana	Lana	20 / 30	Lana

NOTA

- El detergente o suplemento que pueda apelmazarse puede diluirse en un poco de agua antes de ponerlo en el dispensador de detergente, para evitar que la entrada de este se bloquee y provoque el vertido de agua.
- Elija el tipo de detergente adecuado para lograr un rendimiento máximo del lavado y un consumo mínimo de agua y energía.
- Para lograr el mejor resultado de limpieza, es importante una dosificación adecuada del detergente.
- Utilice una cantidad menor de detergente si el tambor no está lleno del todo.
- Ajuste siempre la cantidad de detergente a la dureza del agua. Si su agua de grifo es blanda, utilice menos detergente.
- Dosifique según el grado de suciedad de la ropa. Las prendas menos sucias necesitan menos detergente.
- El detergente muy concentrado (compacto) debe dosificarse con más precisión.

Los siguientes signos son indicativos de un exceso de detergente:

- Mucha formación de espuma
- Lavado y aclarado insuficientes

Los siguientes signos son indicativos de una falta de detergente:

- La ropa se pone gris
- Acumulación de depósitos de cal en el tambor, el elemento calefactor y/o la ropa

Panel de control

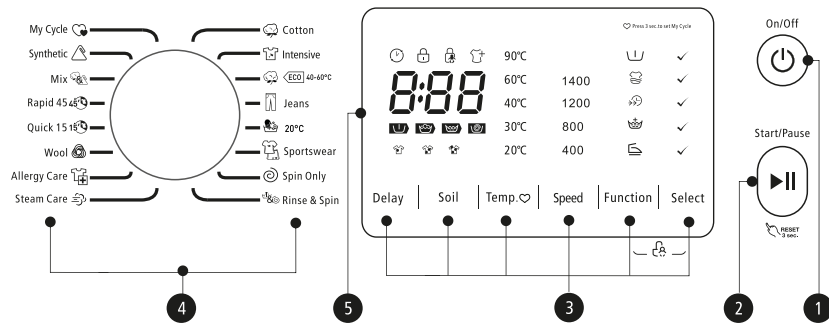
**1 Encendido/Apagado**

Enciende y apaga el aparato.

2 Inicio/Pausa

Inicia o pone en pausa el programa elegido.

3 Opción

Esto le permite elegir funciones adicionales, que se iluminarán al seleccionarse.

4 Programas

Disponibles según el tipo de ropa.

5 Pantalla



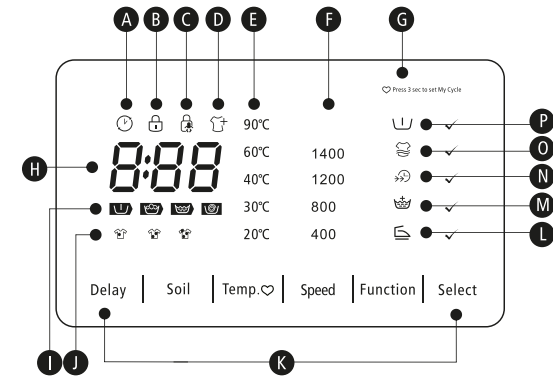









La pantalla muestra los ajustes, el tiempo restante, las opciones y los mensajes de estado.

**A** Inicio programado**B** Bloqueo de puerta**C** Bloqueo infantil**D** Recarga**E** Temp.**F** Velocidad**G** Mi ciclo

H	Tiempo de lavado	Inicio programado	Error	End
I25	2h	E20	End	







I Prelavado-Lavado-Aclarado-Centrifugado**J** Nivel de suciedad**K** Opción**L** Antiarrugas**M** Aclarado extra**N** Lavado rápido**O** Lavado extra**P** Prelavado

Programas

Programa	Carga (kg)			Tiempo en pantalla
> CAPACIDAD DE LA MÁQUINA	7,0	8,0	12,0	7.0/8.0/12.0
 Algodón	7,0	8,0	12,0	3:39
 Intensivo	7,0	8,0	12,0	3:48
 ECO 40-60	7,0	8,0	12,0	3:13/3:32/3:56
 Vaqueros	7,0	8,0	12,0	1:35
 20 °C	3,5	4,0	6,0	1:01
 Ropa de deporte	3,5	4,0	6,0	0:45
 Solo centrifugado	7,0	8,0	12,0	0:12
 Aclarado y centrifugado	7,0	8,0	12,0	0:20
 Vapor	7,0	8,0	12,0	1:47
 Antialergias	3,5	4,0	6,0	2:09
 Lana	2,0	2,0	2,0	1:07
 Quick 15'	2,0	2,0	2,0	0:15
 Rapid 45'	2,0	2,0	2,0	0:45
 Mixto	7,0	8,0	6,0	1:20
 Sintéticos	3,5	4,0	6,0	3:17







- Los datos anteriores son solo una referencia y pueden cambiar debido a que las condiciones reales de uso sean distintas.
- Los valores indicados para los programas que no sean el ECO 40-60 son solo indicativos.
- De acuerdo con la normativa (UE) n.º 1061/2010, La clase de eficiencia energética de la UE es: A+++
Programa de prueba de energía: Intensivo 60/40 °C; Velocidad: La velocidad máxima; Distinto del predeterminado.
Media carga de la máquina de 7,0/8,0/12,0 kg: 3,5/4,0/6,0 kg.
- De acuerdo con la normativa (UE) n.º 2019/2023, La clase de eficiencia energética de la UE es: B
Programa de prueba de energía: ECO 40-60. Distinto del predeterminado.
Media carga de la máquina de 7,0/8,0/12,0 kg: 3,5/4,0/6,0 kg.
Un cuarto de carga de la máquina de 7,0/8,0/12,0 kg: 2,0/2,0/3,0 kg.

Programas

Ciclo	Capacidad nominal en kg	Duración del ciclo en horas y minutos	Consumo de energía en kWh/Ciclo de funcionamiento	Consumo de energía en ml//Ciclo de funcionamiento	Temperatura máxima en °C	Humedad residual en %/Velocidad de centrifugado
 20°C	3,5	1:01	0,100	45	20	65 % / 1000
 Algodón (60°C)	7,0	3:44	1,392	65	60	53 % / 1400
 Intensivo	7,0	3:48	1,000	68	40	70 % / 800
 Mixto	7,0	1:20	0,710	60	40	70 % / 800
 Rápido 15'	2,0	0:15	0,030	40	Cold	75 % / 800
	7,0	-	0,775	54	36	53 % / 1400
  40-60°C	3,5	-	0,47	44	34	53 % / 1400
	2,0	-	0,2	35	21	53 % / 1400







- Los datos anteriores son solo una referencia y pueden cambiar debido a que las condiciones reales de uso sean distintas.
- Las descargas indicadas para los programas que no sean el ECO 40-60 son solo indicativas.
- De acuerdo con la normativa (UE) n.º 1061/2010, La clase de eficiencia energética de la UE es: A+++
Programa de prueba de energía: Intensivo 60/40 °C; Velocidad: La velocidad máxima; Distinto del predeterminado.
Media carga para la máquina de 7,0 kg: 3,5 kg
- De acuerdo con la normativa (UE) n.º 2019/2023, La clase de eficiencia energética de la UE es: B
Programa de prueba de energía: ECO 40-60. Distinto del predeterminado.
Media carga para la máquina de 7,0 kg: 3,5 kg
Un cuarto de carga para la máquina de 7,0 kg: 2,0 kg

Programas

Ciclo	Capacidad nominal en kg	Duración del ciclo en horas y minutos	Consumo de energía en kWh/Ciclo de funcionamiento	Consumo de energía en l//Ciclo de funcionamiento	Temperatura máxima en °C	Humedad residual en %/Velocidad de centrifugado
 20°C	4,0	1:01	0,15	50	20	65 % / 1000
 Algodón (60°C)	8,0	3:44	1,498	70	60	53 % / 1400
 Intensivo	8,0	3:48	1,100	70	40	70 % / 800
 Mixto	8,0	1:20	0,75	65	40	70 % / 800
 Rápido 15'	2,0	0:15	0,030	40	Cold	75 % / 800
	8,0	-	0,857	59	34	53 % / 1400
  40-60°C	4,0	-	0,504	46	29	53 % / 1400
	2,0	-	0,24	37	21	53 % / 1400

- Los datos anteriores son solo una referencia y pueden cambiar debido a que las condiciones reales de uso sean distintas.
- Las descargas indicadas para los programas que no sean el ECO 40-60 son solo indicativas.
- De acuerdo con la normativa (UE) n.º 1061/2010, La clase de eficiencia energética de la UE es: A+++
Programa de prueba de energía: Intensivo 60/40 °C; Velocidad: La velocidad máxima; Distinto del predeterminado.
Media carga para la máquina de 8,0 kg: 4,0 kg
- De acuerdo con la normativa (UE) n.º 2019/2023, La clase de eficiencia energética de la UE es: B
Programa de prueba de energía: ECO 40-60. Distinto del predeterminado.
Media carga para la máquina de 8,0 kg: 4,0 kg
Un cuarto de carga para la máquina de 8,0 kg: 2,0 kg

Programas

Ciclo 12kg	Capacidad nominal en kg	Duración del ciclo en horas y minutos	Consumo de energía en kWh/Ciclo de funcionamiento	Consumo de energía en ml//Ciclo de funcionamiento	Temperatura máxima en °C	Humedad residual en %/Velocidad de centrifugado
 20°C	6,0	1:01	0,206	58	20	65 % / 1000
 Algodón (60°C)	12,0	3:44	1,919	99	60	53 % / 1400
 Intensivo	12,0	3:48	1,417	99	40	70 % / 800
 Mixto	12,0	1:20	0,988	99	40	70 % / 800
 Rápido 15'	2,0	0:15	0,030	40	15	75 % / 800
	12,0	-	1,345	87	40	53 % / 1400
 ECO 40-60°C	6,0	-	0,858	62	38	53 % / 1400
	3,0	-	0,242	42	20	53 % / 1400

- Los datos anteriores son solo una referencia y pueden cambiar debido a que las condiciones reales de uso sean distintas.
- Las descargas indicadas para los programas que no sean el ECO 40-60 son solo indicativas.
- De acuerdo con la normativa (UE) n.º 2019/2023, La clase de eficiencia energética de la UE es: B Programa de prueba de energía: ECO 40-60. Distinto del predeterminado. Media carga para la máquina de 12,0 kg: 6,0 kg Un cuarto de carga para la máquina de 12,0 kg: 3,0 kg

- 2 La máxima temperatura a la que llega la ropa en el ciclo de lavado durante al menos 5 minutos.
- 2 Humedad residual tres el ciclo de lavado en porcentaje de contenido en agua, y la velocidad de centrifugado a la que se logró.

El programa ECO 40-60 puede lavar con normalidad la ropa de algodón sucia que sea lavable a 40 °C o 60 °C, junta en el mismo ciclo. Este programa se utiliza para evaluar el cumplimiento de la normativa (UE) 2019/2023.

Los programas más eficientes en cuanto a consumo de energía suelen ser los de menor temperatura y mayor duración.

Cargar la lavadora hasta la capacidad indicada para cada uno de los programas ayuda a ahorrar energía y agua.

El ruido y la cantidad de humedad restante dependen de la velocidad del centrifugado: cuanto mayor sea la velocidad en la fase de centrifugado, mayor será el ruido y menor será la cantidad de humedad restante.



¡PRECAUCIÓN!













Si hay alguna interrupción en el suministro de alimentación mientras la máquina está en marcha, una memoria especial guardará el programa seleccionado. La máquina continuará el programa cuando el suministro de alimentación se restablezca.

Programas







































































Los programas están disponibles según el tipo de ropa.

Programas

 Sintéticos	Lavado de prendas sintéticas, por ejemplo: camisas, abrigos, mezclas. Para los tejidos de punto, la cantidad de detergente debe reducirse debido a su estructura de fibras sueltas y a la tendencia a formar burbujas. Tejidos resistentes al desgaste, tejidos resistentes al calor hechos de algodón o lino.
 Mixto	Carga mixta de tejidos de algodón y sintéticos.

 Rápido 45'	Este programa es adecuado para lavar ropa que no esté muy sucia y ahorrar energía y lavados.
 Rápido 15'	Programa extracorto, adecuado para ropa ligeramente sucia y para pequeñas cantidades de colada.
 Lana	Tejidos de lana o lana enriquecida lavables a mano o a máquina. Programa especialmente suave para evitar que las prendas encojan, con pausas más prolongadas (las prendas se dejan en líquido de lavado).
 Antialergias	La lavadora puede exterminar eficazmente algunos alérgenos y conseguir un efecto antialergia adaptando la temperatura de 60 °C para la esterilización.
 Vapor	El vapor puede utilizarse para el lavado habitual, como el de algodón o tejidos sintéticos. El vapor penetra profundamente en la fibra, la cual elimina eficazmente bacterias y gérmenes, previniendo olores y protegiendo su salud.
 Aclarado y centrifugado	Aclarado adicional con centrifugado.
 Solo centrifugado	Centrifugado adicional con selección de velocidad.
 Ropa de deporte	Para lavar la ropa de deporte.
 20 °C	20 °C predeterminados, se puede elegir agua fría.
 Vaqueros	Especial para vaqueros.
 ECO 40-60 °C	40 °C predeterminados, no seleccionable, adecuado para el lavado de colada a unos 40 °C-60 °C.
 Intensivo	Para aumentar los efectos del lavado se aumenta el tiempo de lavado.
 Algodón	Tejidos resistentes al desgaste, tejidos resistentes al calor hechos de algodón o lino.

Opción

Ciclo	Prede-terminado Temp. (°C)	Velocidad de centrifugado prede-terminada en rpm	Funciones adicionales
Ciclos de lavado		1400	
 Sintéticos	40	1200	 ,  ,  ,  ,  , 
 Mixto	40	800	 ,  ,  ,  ,  , 
 Rápido 45'	40	800	 ,  ,  , 
 Rápido 15'	Frío	800	
 Lana	40	800	 ,  , 
 Antialergias	60	800	 ,  ,  ,  , 
 Vapor	40	800	 ,  ,  ,  ,  , 
 Aclarado y centrifugado	-	800	 ,  , 
 Solo centrifugado	-	800	 , 
 Ropa de deporte	20	800	 ,  ,  , 
 20 °C	20	800	 ,  , 
 Vaqueros	30	800	 ,  ,  , 
 ECO 40-60 °C	-	1400	
 Intensivo	40	800	
 Algodón	40	1400	 ,  ,  ,  ,  , 

NOTA

- Consulte la velocidad máxima de centrifugado, la duración y otros detalles del programa ECO 40-60 en la página de programas.
- La tabla muestra qué opciones de ajuste ofrece cada ciclo.

Temp.

Temp.

En caso necesario, la temperatura de lavado puede ajustarse pulsando el botón de temperatura con el siguiente orden: Frío - 20 °C - 30 °C - 40 °C - 60 °C - 90 °C.

Delay

Inicio programado

Ajuste de la función de inicio diferido:

- 1 Seleccione un programa.
- 2 Pulse el botón de inicio diferido para elegir la hora (el tiempo diferido es de entre 0 y 24 h).

Pulse [Inicio/Pausa] para empezar la cuenta atrás.



Seleccione el programa



Ajuste de la hora



Start

Cancelación de la función de inicio diferido:

Pulse el botón [Delay] (inicio diferido) hasta que la pantalla se quede en 0 h. Debe pulsarse antes de iniciar el programa. Si el programa ya ha empezado, debe cancelarse e iniciarse uno nuevo.

Soil

Suciedad

El tiempo de lavado aumentará o se reducirá al seleccionarlo.

**Prelavado**

La función de prelavado puede hacer un lavado adicional antes del principal. Es adecuada para quitar el polvo de la superficie de la ropa. Cuando se selecciona, hay que poner detergente en el compartimento (I).

**Lavado extra**

Para ropa muy sucia. Aumenta el tiempo y la intensidad del lavado para aumentar su efecto.

**Lavado rápido**

Esta función reduce el tiempo de lavado.

**Aclarado extra**

Si se selecciona, la ropa se someterá a un aclarado adicional.

**Mi ciclo**

Para guardar los programas más usados.

Después de elegir el programa y ajustar las opciones, pulse [Temp.] 3 segundos antes de empezar el lavado. El programa predeterminado es el de algodón.

**Antiarrugas**

La función antiarrugas puede utilizarse para reducir las arrugas de la ropa.

**Recarga**

Esta operación puede ejecutarse durante el lavado, cuando el tambor todavía está girando y tiene una gran cantidad de agua a elevada temperatura.

El estado no es seguro y no puede forzarse la puerta para que se abra.

Pulse [Inicio/Pausa] durante 3 segundos para recargar y añada la ropa en la fase intermedia. Siga los siguientes pasos:

- ❶ Espere a que el tambor deje de girar.
- ❷ La puerta se desbloquea.
- ❸ Cierre la puerta cuando haya metido la ropa y pulse el botón [Inicio/Pausa].



Pulse [Inicio/Pausa] 3 segundos



Meta la ropa



Start

**Bloqueo infantil**

Evita que los niños usen la máquina.

Pulse la función y [Select] durante 3 segundos hasta que suene el avisador.

Function

Select

**¡PRECAUCIÓN!**

Si el bloqueo infantil está activado y el programa empieza, el indicador del bloqueo infantil se encenderá y en la pantalla aparecerán alternativamente CL (siglas de bloqueo infantil) y el tiempo restante en intervalos de 0,5 s.

Si pulsa los otros botones, el bloqueo infantil parpadeará durante 3 segundos. Cuando el programa termine, en la pantalla se alternarán CL y END durante 10 segundos. A continuación, la luz del bloqueo infantil parpadeará 3 segundos.

- Solo mantener pulsados los dos botones puede liberar el bloqueo infantil, incluso apagar, desconectar y finalizar el programa.
- El bloqueo infantil bloquea todos los botones excepto el de encendido y el de bloqueo infantil.
- Libere el bloqueo infantil antes de seleccionar otro programa y empezar a lavar.

Temp.

Temp.

Pulse este botón para regular la temperatura (frío, 20 °C, 30 °C, 40 °C, 60 °C, 90 °C).

Function

Seleccionar opción

Seleccione la función de Pre Wash, Extra Rinse, Extra Wash, Night Wash o Anti-crease.

Select

Confirmar opción

Confirme su selección de Pre Wash, Extra Rinse, Speed Wash, Night Wash o Anti-crease function.

Speed

Velocidad

Pulse el botón para cambiar la velocidad.
1400: 0-400-800-1200-1400

Limpieza y mantenimiento

¡ADVERTENCIA!

Desenchufe el aparato y cierre la toma de agua siempre que vaya a hacer la limpieza y el mantenimiento del aparato.

Limpieza de la carcasa

El mantenimiento adecuado de la lavadora puede ampliar su vida útil. Cuando sea necesario, la superficie puede limpiarse con detergentes neutrales y no abrasivos diluidos en agua. Si se vierte agua, límpiela de inmediato con un paño. No utilice nunca objetos afilados para limpiar el aparato.



¡PRECAUCIÓN!

No utilice nunca calor o sustancias corrosivas, ácido fórmico o sus disolventes diluidos ni sustancias similares como alcohol o productos químicos.

Limpieza del tambor

Cualquier mancha de óxido que hayan dejado en el tambor los artículos metálicos debe eliminarse de inmediato con detergentes sin cloro. ¡No utilice nunca un estropajo de acero para limpiar el tambor!

NOTA

Mantenga la ropa alejada de la máquina mientras limpia el tambor.

Limpieza de la goma y el cristal de la puerta

Pase un paño por el cristal y la goma después de cada lavado para quitar las pelusas y las manchas. Si las pelusas se acumulan, pueden provocar bloqueos. Después de cada lavado, retire las monedas, botones u otros objetos que puedan haber caído en la goma.

Limpie la goma y el cristal de la puerta una vez al mes para asegurarse del normal funcionamiento del aparato.

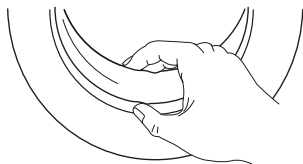

Limpieza del filtro de entrada

NOTA

Un caudal de agua reducido es un signo de que el filtro debe limpiarse.

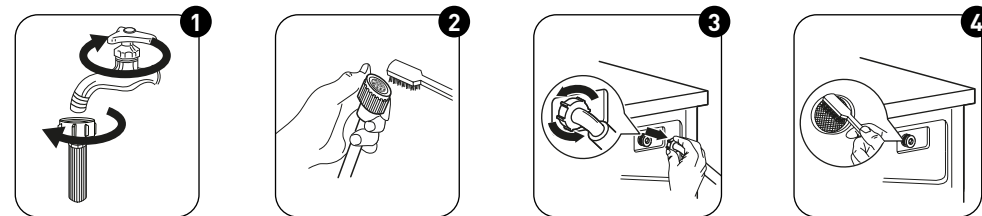

- 1 Cierre la toma y separe de ella el tubo de suministro de agua.
- 2 Limpie el filtro con un cepillo.
- 3 Desenrosque el tubo de suministro de agua de la parte trasera de la máquina. Saque el filtro con unos alicates de punta larga.
- 4 Use un cepillo para limpiar el filtro.
- 5 Vuelva a colocar el filtro en la entrada de agua y reconecte el tubo de suministro de agua.

Limpie el filtro de entrada cada 3 meses para asegurarse del funcionamiento normal del aparato.

Limpieza del dispensador de detergente

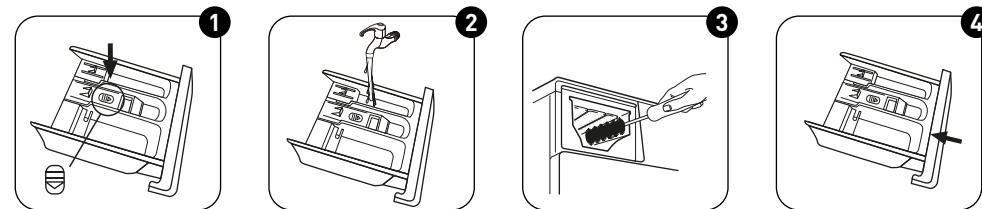

- 1 Pulse el botón de extracción y saque el dispensador.
- 2 Limpie el dispensador y la tapa para suavizante debajo del agua.
- 3 Limpie el hueco con un cepillo suave.
- 4 Vuelva a colocar el dispensador.

NOTA

- No utilice sustancias abrasivas ni corrosivas para limpiar las piezas de plástico.
- Limpie el dispensador de detergente cada 3 meses para asegurarse del funcionamiento normal del aparato.

Limpieza del filtro de la bomba de drenaje**¡ADVERTENCIA!**

- ¡Tenga cuidado con el agua caliente!
- Espere a que la solución de detergente se enfríe.
- Desconecte la máquina para evitar descargas eléctricas antes del lavado.
- El filtro de la bomba de drenaje puede filtrar hebras y objetos extraños pequeños durante el lavado.
- Limpie el filtro periódicamente para asegurarse del funcionamiento normal de la lavadora.

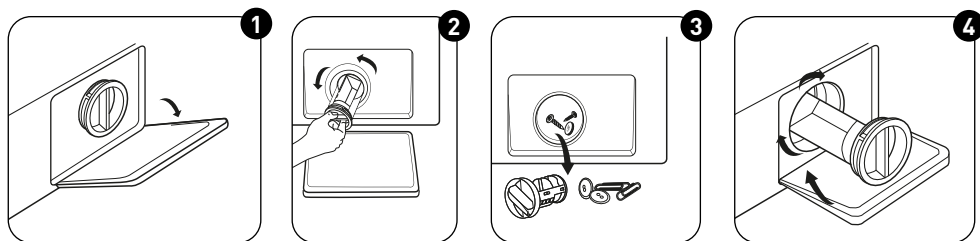

- 1 Abra la tapa inferior
- 2 Abra el filtro girándolo en sentido antihorario
- 3 Quite los objetos extraños
- 4 Cierre la tapa inferior

¡PRECAUCIÓN!

- Asegúrese de que la tapa de la válvula y el tubo de drenaje de emergencia vuelven a colocarse correctamente. Las tapas deben insertarse alineándose con los orificios. De lo contrario, podría haber fugas de agua.
- Algunas máquinas no tienen tubo de drenaje de emergencia, por lo que no hay que hacer los pasos 2 y 3. Gire la tapa inferior directamente para que el agua se vierta en un recipiente.
- Cuando el aparato se está utilizando, y dependiendo del programa seleccionado, puede haber agua caliente en la bomba. No quite nunca la tapa de la bomba durante un ciclo de lavado. Espere siempre a que el aparato haya finalizado el ciclo y esté vacío. Cuando vuelva a colocar la tapa, asegúrese de que se vuelva a colocar con firmeza.

Solución de problemas

Si hay algún problema con el aparato, compruebe si puede solucionarlo con la siguiente tabla. Si el problema continúa, contacte con el servicio de atención al cliente.

Descripción	Posible causa	Solución
El aparato no arranca	La puerta no está bien cerrada. La ropa se ha enganchado.	Cierre bien la puerta y reinicie. Compruebe la ropa.
La puerta no se abre.	La protección de seguridad está activada.	Desconecte la alimentación y reinicie.
Fugas de agua	Las conexiones no están bien apretadas.	Revise y apriete el tubo de entrada de agua. Revise y limpie el tubo de salida.
Hay residuos de detergente en el dispensador de detergente.	El detergente está húmedo y/o apelmazado.	Limpie y seque con un paño el dispensador de detergente.
El indicador o la pantalla no funciona.	Hay problemas de conexión en el tablero del circuito impreso o el cableado.	Apague la alimentación y compruebe si el enchufe de red está bien conectado.
Ruido anormal	Los pernos de fijación todavía están puestos. El suelo no es sólido o plano.	Compruebe si los pernos de fijación se han quitado. Asegúrese de que el aparato esté instalado en una superficie sólida y plana.

Códigos de error

Descripción	Posible causa	Solución
E30	La puerta no está bien cerrada.	Cierre bien la puerta y reinicie.
E10	Problema de inyección de agua durante el ciclo de lavado.	Compruebe que la presión de agua es suficiente. Ponga recto el tubo de agua. Limpie el filtro de la válvula de entrada.
E21	Tiempo excesivo del drenaje de agua	Compruebe si el tubo de drenaje está bloqueado.
E12	Rebosamiento de agua	Reinicie el aparato.
EXX	Otros	Reinicie el aparato. Si el problema continúa, contacte con el servicio de atención al cliente.

Atención al cliente

Hay disponibles piezas de repuesto de su aparato durante al menos 10 años. En caso de preguntas, contacte con nuestro servicio de atención al cliente en:

¡ADVERTENCIA!

Riesgo de descarga eléctrica.

- Nunca intente reparar un aparato defectuoso o que crea que está averiado. Puede poner en peligro su vida y la de otros futuros usuarios. Este trabajo de reparación solo puede ser realizado por especialistas autorizados.
- ¡Una reparación inadecuada invalida la garantía y la reparación de los daños subsiguientes!

Transporte

PASOS IMPORTANTES PARA MOVER EL APARATO

- Desenchufe el aparato y cierre la toma de agua.
- Compruebe que la puerta y el dispensador de detergente estén bien cerrados.
- Quite el tubo de entrada de agua y el tubo de salida de las conexiones de la carcasa.
- Drene totalmente el agua del aparato (vea el apartado sobre mantenimiento del filtro de la bomba de drenaje).
- Importante: Vuelva a colocar los 4 pernos de transporte en la parte trasera del aparato.
- Este aparato es pesado. Transpórtelo con cuidado. Nunca sostenga la máquina por una parte saliente de la misma cuando la levante. La puerta de la máquina no puede utilizarse como empuñadura.

Grazie !

Grazie di aver scelto questo prodotto VALBERG. Scelti, testati e raccomandati da ELECTRO DEPOT, i prodotti a marchio VALBERG assicurano un utilizzo semplice, prestazioni affidabili e una qualità impeccabile.

Grazie a questo apparecchio, ogni utilizzo sarà motivo di soddisfazione.

Benvenuto in ELECTRO DEPOT.

Visita il nostro sito internet: www.electrodepot.fr

Indice

A **Panoramica
dell'apparecchio**

Panoramica dell'apparecchio

B **Utilizzo
dell'apparecchio**

Installazione
Funzionamento

C **Informazioni utili**

Pulizia e manutenzione
Risoluzione dei problemi
Servizio clienti

Panoramica dell'apparecchio

- ❶ Tubo d'ingresso dell'acqua
- ❷ Scomparto dei detersivi
- ❸ Oblò
- ❹ Piano di lavoro
- ❺ Pannello di controllo
- ❻ Cavo di alimentazione elettrica
- ❼ Cestello
- ❽ Portello per manutenzione
- ❾ Tubo di scarico
- ❿ 4 tappi in plastica
- ⓫ 1 tubo di alimentazione dell'acqua fredda

NOTA

La rappresentazione grafica dell'apparecchio è fornita a titolo puramente indicativo: si prega di fare riferimento al proprio prodotto specifico.

Installazione

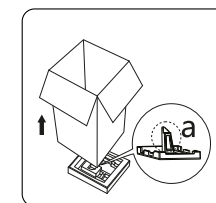
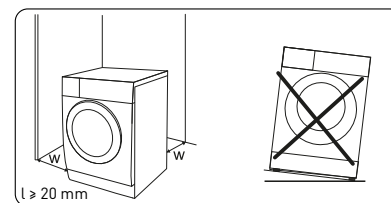

Luogo d'installazione

AVVERTENZA!

- È importante assicurare la corretta stabilità per evitare che la lavatrice si muova! Assicurarsi che la lavatrice sia in piano e stabile.
- Assicurarsi che l'apparecchio non poggi sul cavo di alimentazione elettrica.
- Assicurarsi che le distanze minime indicate in figura siano rispettate tra l'apparecchio e le pareti.

Prima di installare l'apparecchio, scegliere un luogo con le seguenti caratteristiche:

- ❶ Superficie rigida, asciutta e piana;
- ❷ Al riparo dalla luce diretta del sole;
- ❸ Ventilazione adeguata;
- ❹ Una temperatura ambiente superiore a 0°C;
- ❺ Lontano da fonti di calore, specialmente da apparecchi alimentati a carbone o a gas.

Disimballare la lavatrice

AVVERTENZA!

- I materiali di imballaggio (ad es. le pellicole, il polistirolo) possono essere pericolosi per i bambini.
- Rappresentano un rischio di soffocamento! Conservare i materiali di imballaggio lontano dalla portata dei bambini.

- ❶ Rimuovere la scatola di cartone e l'imballaggio di polistirolo.
- ❷ Sollevare la lavatrice e rimuovere la base dell'imballaggio. Assicurarsi di rimuovere il piccolo triangolo di materiale espanso unitamente alla base. In caso contrario, adagiare

l'apparecchio su un lato e rimuoverlo manualmente.

- ➊ Rimuovere il nastro adesivo che trattiene il cavo dell'alimentazione elettrica e il tubo di scarico.
- ➋ Rimuovere il tubo di ingresso dal cestello.

Rimuovere i bulloni di protezione per il trasporto

AVVERTENZA!

Rimuovere i bulloni di protezione per il trasporto situati sul retro dell'apparecchio prima di utilizzarlo.



- ➊ Svitare i 4 bulloni di protezione per il trasporto con una chiave.
- ➋ Rimuovere i bulloni, comprese le parti in gomma, e conservarli per un uso futuro.
- ➌ Richiudere i fori con i tappi di plastica.

Livellamento della lavatrice

AVVERTENZA!

I controdadi situati sui quattro piedini devono essere ben serrati contro il telaio dell'apparecchio.



- ➊ Allentare il controdado.
- ➋ Ruotare i piedini fino a raggiungere il pavimento.
- ➌ Regolare i piedini e bloccare i dadi con una chiave. Assicurarsi che la lavatrice sia in piano e stabile.

Collegamento del tubo di ingresso dell'acqua

AVVERTENZA!

Per evitare perdite o danni dovuti all'acqua, seguire le istruzioni contenute in questo paragrafo. Non piegare, schiacciare o modificare il tubo di ingresso dell'acqua.

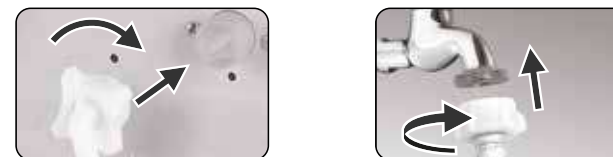

Collegare il tubo di ingresso dell'acqua alla valvola di ingresso dell'acqua e a un rubinetto di acqua fredda come indicato in figura.

NOTA

Effettuare il collegamento manualmente, senza servirsi di utensili. Verificare che tutti i collegamenti siano ben serrati.

Tubo di scarico

AVVERTENZA!

- Evitare di piegare o di allungare il tubo di scarico.
- Posizionare correttamente il tubo di scarico per evitare perdite d'acqua.

Esistono due possibilità per posizionare l'estremità del tubo di scarico:

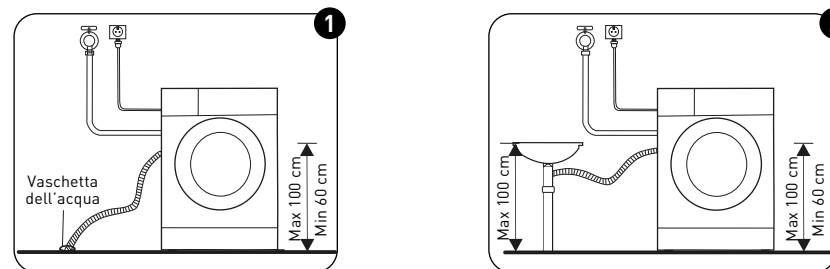

- ➊ Collocarlo nella vaschetta dell'acqua.
- ➋ Collegare l'estremità del tubo alla condotta di scarico del lavandino.

Funzionamento

Guida introduttiva rapida

ATTENZIONE!

- Prima di iniziare il lavaggio, assicurarsi di aver installato correttamente la lavatrice.
- L'apparecchio è stato accuratamente controllato prima di lasciare la fabbrica. Per rimuovere completamente l'acqua residua e neutralizzare eventuali odori, si consiglia di pulire l'apparecchio prima di utilizzarlo per la prima volta. A tal proposito, avviare il programma Cotone a 90°C senza carico né detersivo.

CALIBRAZIONE

Si raccomanda di calibrare la lavatrice per ottenere ottime prestazioni. L'apparecchio è in grado di rilevare la quantità di bucato caricata. Questa funzione ottimizza il rendimento dell'apparecchio, riducendo il consumo di energia e di acqua e consente di risparmiare tempo e denaro. Pertanto, si consiglia di calibrare l'apparecchio per ottenere risultati eccellenti.

- 1 Rimuovere tutti gli accessori dal cestello e chiudere l'oblò;
- 2 Inserire la spina nella presa di corrente;
- 3 Accendere la lavatrice e premere contemporaneamente i pulsanti Delay e Temp. per 10 secondi fino a visualizzare «t19»;
- 4 Premere [▶||] per avviare l'apparecchio e attendere che compaiano i simboli "****".

1 Prima del lavaggio

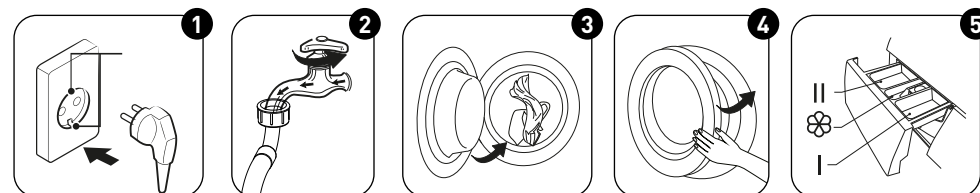

- 1 Collegare l'apparecchio alla corrente elettrica
- 2 Aprire il rubinetto
- 3 Inserire il carico nella lavatrice
- 4 Chiudere l'oblò
- 5 Aggiungere il detersivo

NOTA

Il detersivo deve essere aggiunto nello scomparto I se è stata selezionata la funzione di prelavaggio.

2 Lavaggio

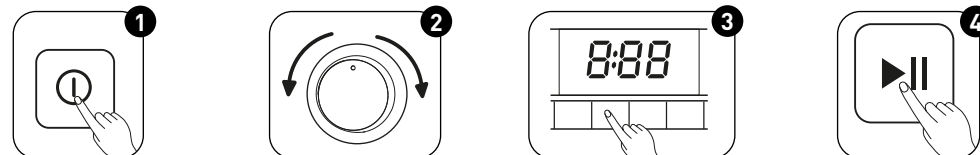

- 1 Accendere la lavatrice
- 2 Selezionare un programma
- 3 Selezionare una funzione o mantenere le impostazioni predefinite
- 4 Premere il tasto Avvio/Pausa per avviare il programma

3 Alla fine del lavaggio

Verrà emesso un segnale sonoro e comparirà la scritta "End" (Fine).

Prima di ogni lavaggio

- L'apparecchio deve funzionare a una temperatura ambiente compresa tra 5 e 40°C. Se l'apparecchio viene usato a temperature inferiori a 0°C, la valvola di ingresso dell'acqua e il sistema di scarico possono essere danneggiati. Se si verificano temperature gelide quando la lavatrice è installata, l'apparecchio deve essere spostato in una stanza con temperatura ambiente normale per permettere al tubo di ingresso e al tubo di scarico dell'acqua di scongelarsi prima dell'uso.
- Controllare le etichette di cura dei capi e le istruzioni per l'impiego di detersivo prima di iniziare il lavaggio. Utilizzare detersivi poco o per niente schiumogeni, adatti al lavaggio in lavatrice.

AVVERTENZA!

- Non lavare né asciugare mai articoli che siano stati puliti, lavati, imbevuti o tamponati con sostanze combustibili o esplosive (compresi cera, petrolio, vernice, benzina, alcol, paraffina o altre sostanze infiammabili).
- Il lavaggio di un singolo articolo può provocare un difetto di centratura e far scattare un allarme a causa dello sbilanciamento rilevato. È quindi consigliabile aggiungere uno o due articoli in più, per garantire che il processo di asciugatura venga eseguito correttamente.

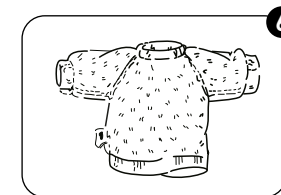
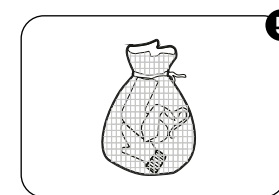
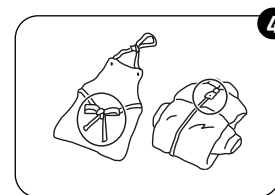
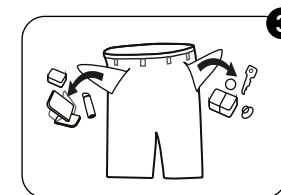
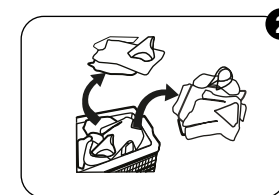
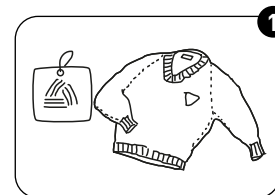

- 1 Verificare le etichette di cura
- 2 Selezionare il bucato in base al colore e al tipo di tessuto
- 3 Svuotare completamente le tasche
- 4 Legare insieme le cinture e le lunghe strisce di tessuto, chiudere bottoni e cerniere
- 5 Posizionare gli articoli di dimensioni ridotte in una rete per il lavaggio
- 6 Rivoltare i tessuti che formano pelucchi o a pelo lungo

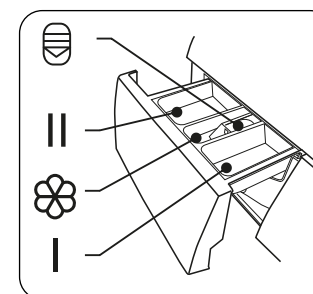
Scomparto dei detersivi

I Prelavaggio

















II Lavaggio principale

🌸 Ammorbidente

🔒 Pulsante di sblocco per rimuovere lo scomparto

ATTENZIONE!

Mettere il detersivo nello «scomparto I» solo se è stata selezionata la funzione di prelavaggio.

Programma	I	II	
 Sintetici	<input type="radio"/>	<input checked="" type="radio"/>	<input type="radio"/>
 Tessuti misti	<input type="radio"/>	<input checked="" type="radio"/>	<input type="radio"/>
 Rapido 45'	<input type="radio"/>	<input checked="" type="radio"/>	<input type="radio"/>
 Rapido 15'		<input checked="" type="radio"/>	<input type="radio"/>
 Lana		<input checked="" type="radio"/>	<input type="radio"/>
 Anti-allergeni	<input type="radio"/>	<input checked="" type="radio"/>	<input type="radio"/>
 Vapore	<input type="radio"/>	<input checked="" type="radio"/>	<input type="radio"/>
 Risciacquo & Centrifuga			<input type="radio"/>
 Solo centrifuga			
 Indumenti sportivi	<input type="radio"/>	<input checked="" type="radio"/>	<input type="radio"/>
 20 °C		<input checked="" type="radio"/>	<input type="radio"/>
 Jeans	<input type="radio"/>	<input checked="" type="radio"/>	<input type="radio"/>
 ECO 40-60		<input checked="" type="radio"/>	<input type="radio"/>
 Intensivo		<input checked="" type="radio"/>	<input type="radio"/>
 Cotone	<input type="radio"/>	<input checked="" type="radio"/>	<input type="radio"/>

● Obbligatorio ○ Facoltativo

Consigli per i detersivi

Detersivo raccomandato	Cicli di lavaggio	Temp. di lavaggio	Tipologie di carico e tessuti
Potente detersivo contenente agenti sbiancanti e azzurranti ottici	Cotone ECO 40-60, Tessuti misti, Jeans, Intensivo	20/30/40/60	Tessuti bianchi di lino o di cotone resistente alle alte temperature
Detersivo per colorati privo di agenti sbiancanti e azzurranti ottici	Cotone ECO 40-60, Tessuti misti, Jeans, Intensivo	A freddo/20/30/40	Tessuti colorati di lino o cotone
Detersivo delicato o per colorati privo di azzurranti ottici	Sintetici	A freddo/20/30/40	Tessuti colorati, composti da fibre sintetiche o di facile manutenzione
Detersivo delicato	Sintetici	20/30	Tessuti delicati, seta, viscosa
Detersivo speciale per lana	Lana	20/30	Lana

NOTA

- Se il detersivo o l'additivo hanno un aspetto grumoso o viscoso, possono essere diluiti con acqua prima di versarli nello scomparto dei detersivi. Ciò previene l'ostruzione del foro dello scomparto ed eventuali fuoriuscite d'acqua.
- Scegliere il giusto tipo di detersivo per ottenere le migliori prestazioni di lavaggio con il minor consumo possibile di acqua ed energia.
- Per un lavaggio ottimale, è importante dosare correttamente il detersivo.
- Utilizzare una quantità ridotta di detersivo se il cestello non è completamente pieno.
- Regolare sempre la quantità di detersivo in base alla durezza dell'acqua: Se l'acqua del rubinetto non è molto dura, impiegare meno detersivo.
- Dosare il detersivo a seconda del livello di sporco dei capi: i capi poco sporchi hanno bisogno di meno detersivo.
- I detersivi molto concentrati richiedono un dosaggio particolarmente preciso.

La seguente casistica indica un sovradosaggio di detersivo:

- formazione di una grande quantità di schiuma;
- scarse prestazioni di lavaggio e risciacquo.

La seguente casistica indica un dosaggio insufficiente di detersivo:

- tendenza del bucato a ingrigire;
- depositi di calcare si accumulano sul cestello, sulla resistenza e/o sul bucato.

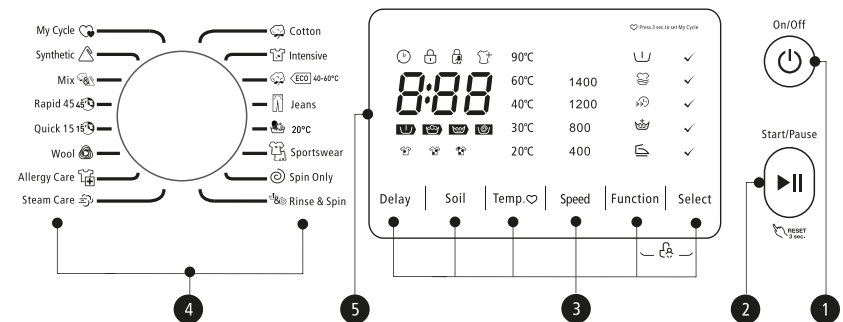
Pannello di controllo**1 Alimentazione**

Consente di accendere e spegnere l'apparecchio.

2 Avvio/Pausa

Consente di avviare o di interrompere il programma selezionato.

3 Opzioni

Consentono di selezionare le funzioni supplementari. La spia corrispondente si accende quando l'opzione è stata selezionata.

4 Programmi

Disponibili a seconda del tipo di tessuto.

5 Display

Il display indica le impostazioni, la durata stimata rimanente, le opzioni e i messaggi di stato.

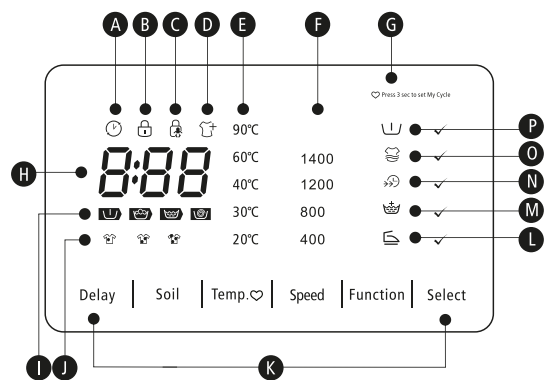

A Avvio ritardato

B Blocco oblò

C Protezione bambini

D Aggiunta di carico

E Temp.

F Velocità

G Ciclo personalizzato

H Durata del lavaggio Avvio ritardato Errore Fine
 125 2h E20 End

I Prelavaggio-lavaggio-risciacquo-centrifuga

J Livello di sporco

K Opzioni

L Anti-sgualcitura

M Risciacquo extra

N Lavaggio rapido

O Lavaggio extra







P Prelavaggio

Programmi

Programma	Carico (kg)			Durata indicata
> CAPACITÀ LAVATRICE	7,0	8,0	12,0	7,0/8,0/12,0
Cotone	7,0	8,0	12,0	03:39
Intensivo	7,0	8,0	12,0	03:48
ECO 40-60°C	7,0	8,0	12,0	3:13/3:32/3:56
Jeans	7,0	8,0	12,0	01:35
20 °C	3,5	4,0	6,0	01:01
Indumenti sportivi	3,5	4,0	6,0	00:45
Solo centri-fuga	7,0	8,0	12,0	00:12
Risciacquo & Centrifuga	7,0	8,0	12,0	00:20
Vapore	7,0	8,0	12,0	01:47
Anti-allergeni	3,5	4,0	6,0	02:09
Lana	2,0	2,0	2,0	01:07
Rapido 15'	2,0	2,0	2,0	00:15
Rapido 45'	2,0	2,0	2,0	00:45
Tessuti misti	7,0	8,0	6,0	01:20
Sintetici	3,5	4,0	6,0	03:17

- I dati di cui sopra sono forniti solo a titolo indicativo e possono variare a seconda delle reali condizioni di utilizzo.
- Fatta eccezione per il programma ECO 40-60, i valori indicati per i programmi sono puramente indicativi.
- Secondo il regolamento (UE) n°1061/2010:
la classe di efficienza energetica europea è: A+++
Programma di test energetico: Intensivo 60/40 °C; Velocità: velocità massima;
altre impostazioni predefinite.
mezzo carico per una lavatrice da 7,0/8,0/12,0 kg: 3,5/4,0/6,0 kg.
- Secondo il regolamento (UE) n°2019/2023:
la classe di efficienza energetica europea è: B
Programma di test energetico: ECO 40-60 Altre impostazioni predefinite.
mezzo carico per una lavatrice da 7,0/8,0/12,0 kg: 3,5/4,0/6,0 kg. mezzo carico per una lavatrice da 7,0/8,0/12,0 kg: 2,0/2,0/3,0 kg.

Programmi

Ciclo	Capacità nominale in kg	Durata del ciclo in ore e minuti	Consumo di energia in kWh/ciclo di funzionamento	Consumo di acqua in litri/ciclo di funzionamento	Temperatura più elevata in °C	Umidità residua in %/velocità di centrifuga
 20°C	3,5	01:01	0,100	45	20	65 %/1.000
 Cotone (60°C)	7,0	03:44	1,392	65	60	53 %/1.400
 Intensivo	7,0	03:48	1,000	68	40	70 %/800
 Tessuti misti	7,0	01:20	0,710	60	40	70 %/800
 Rapido 15'	2,0	00:15	0,030	40	Freddo	75 %/800
 ECO 40-60°C	7,0	-	0,775	54	36	53 %/1.400
	3,5	-	0,47	44	34	53 %/1.400
	2,0	-	0,2	35	21	53 %/1.400

- I dati di cui sopra sono forniti soltanto a titolo indicativo e possono variare a seconda delle reali condizioni di utilizzo.
- Fatta eccezione per il programma ECO 40-60, i valori indicati per i programmi sono puramente indicativi.
- Secondo il regolamento (UE) n°1061/2010:
la classe di efficienza energetica europea è: A+++
Programma di test energetico: Intensivo 60/40 °C; Velocità: velocità massima;
altre impostazioni predefinite.
Mezzo carico per una lavatrice da 7,0 kg: 3,5 kg.
- Secondo il regolamento (UE) n°2019/2023:
la classe di efficienza energetica europea è: B
Programma di test energetico: ECO 40-60 Altre impostazioni predefinite. Mezzo carico per una lavatrice da 7,0 kg: 3,5 kg.
Un quarto di carico per una lavatrice da 7,0 kg: 2,0 kg.

Programmi

Ciclo	Capacità nominale in kg	Durata del ciclo in ore e minuti	Consumo di energia in kWh/ciclo di funzionamento	Consumo di energia in kWh/ciclo di funzionamento	Temperatura più elevata in °C	Umidità residua in %/velocità di centrifuga
20°C	4,0	01:01	0,15	50	20	65 %/1.000
Cotone (60°C)	8,0	03:44	1,498	70	60	53 %/1.400
Intensivo	8,0	03:48	1,100	70	40	70 %/800
Tessuti misti	8,0	01:20	0,75	65	40	70 %/800
Rapido 15'	2,0	00:15	0,030	40	Freddo	75 %/800
ECO 40-60°C	8,0	-	0,857	59	34	53 %/1.400
	4,0	-	0,504	46	29	53 %/1.400
	2,0	-	0,24	37	21	53 %/1.400

- I dati di cui sopra sono forniti soltanto a titolo indicativo e possono variare a seconda delle reali condizioni di utilizzo.
- Fatta eccezione per il programma ECO 40-60, i valori indicati per i programmi sono puramente indicativi.
- Secondo il regolamento (UE) n°1061/2010 :
la classe di efficienza energetica europea è: A+++
Programma di test energetico: Intensivo 60/40 °C; Velocità: velocità massima;
altre impostazioni predefinite. Mezzo carico per una lavatrice da 8,0 kg: 4,0 kg.
- Secondo il regolamento (UE) n°2019/2023: la classe di efficienza energetica europea è: B
Programma di test energetico: ECO 40-60 Altre impostazioni predefinite. Mezzo carico per una lavatrice da 8,0 kg: 4,0 kg. Un quarto di carico per una lavatrice da 8,0 kg: 2,0 kg.

Programmi

Ciclo	Capacità nominale in kg	Durata del ciclo in ore e minuti	Consumo di energia in kWh/ciclo di funzionamento	Consumo di energia in kWh/ciclo di funzionamento	Temperatura più elevata in °C	Umidità residua in %/velocità di centrifuga
20°C	6,0	01:01	0,206	58	20	65 %/1.000
Cotone (60°C)	12,0	03:44	1,919	99	60	53 %/1.400
Intensivo	12,0	03:48	1,417	99	40	70 %/800
Tessuti misti	12,0	01:20	0,988	99	40	70 %/800
Rapido 15'	2,0	00:15	0,030	40	15	75 %/800
	12,0	-	1,345	87	40	53 %/1.400
ECO 40-60°C	6,0	-	0,858	62	38	53 %/1.400
	3,0	-	0,242	42	20	53 %/1.400

- I dati di cui sopra sono forniti soltanto a titolo indicativo e possono variare a seconda delle reali condizioni di utilizzo.
- Fatta eccezione per il programma ECO 40-60, i valori indicati per i programmi sono puramente indicativi.
- Secondo il regolamento (UE) n°2019/2023:
la classe di efficienza energetica europea è: B
Programma di test energetico: ECO 40-60 Altre impostazioni predefinite. Mezzo carico per una lavatrice da 12,0 kg: 6,0 kg. Un quarto di carico per una lavatrice da 12,0 kg: 3,0 kg.

- ❶ Temperatura più alta raggiunta dal carico durante il ciclo di lavaggio per almeno 5 minuti.
- ❷ Umidità residua dopo il ciclo di lavaggio come percentuale del contenuto d'acqua e velocità di centrifuga alla quale questo valore è stato ottenuto.
- ❸ Il programma ECO 40-60 consente di lavare tessuti di cotone normalmente sporchi e lavabili insieme a 40°C o 60°C nello stesso ciclo. Questo programma viene utilizzato per valutare la conformità con il regolamento (UE) 2019/2023.

I programmi più efficienti dal punto di vista energetico sono generalmente quelli che funzionano alle temperature più basse e che hanno una durata più lunga.

Caricare la lavatrice domestica fino alla capacità massima specificata dal costruttore per il programma in questione contribuisce a risparmiare energia e acqua.

Il rumore e la percentuale di umidità residua sono influenzati dalla velocità di centrifuga: maggiore è la velocità di rotazione durante la fase di centrifuga, maggiore sarà il rumore e minore sarà la percentuale di umidità residua.



ATTENZIONE!













In caso di mancanza di corrente elettrica durante il funzionamento della lavatrice, una memoria speciale memorizzerà il programma selezionato. Il programma riprenderà una volta ripristinata la corrente elettrica.

Programmi



































































I programmi seguenti sono disponibili a seconda del tipo di articolo.

Programmi

	Sintetici	Lavaggio di articoli sintetici, ad esempio: camicie, cappotti, fibre miste. Per il lavaggio dei tessuti a maglia, la quantità di detersivo deve essere ridotta; infatti i tessuti a maglie larghe favoriscono la formazione di schiuma. Tessuti compatti e resistenti al calore in cotone o lino.
	Tessuti misti	Tessuti misti di cotone e sintetici.
	Rapido 45'	Questo programma è adatto per lavare gli indumenti poco sporchi. Consente di ridurre il consumo di energia.

	Rapido 15'	Programma molto breve, adatto a piccole quantità di indumenti poco sporchi. Per lana lavabile a mano o in lavatrice o per tessuti con elevata percentuale in lana. Si tratta di un programma di lavaggio particolarmente delicato che previene il restringimento del bucato, con pause più lunghe durante il programma (i tessuti vengono immersi nel liquido di lavaggio).
	Lana	La lavatrice consente di rimuovere efficacemente alcuni allergeni e ha un effetto antiallergico, utilizzando una temperatura di 60°C per la sterilizzazione.
	Anti-allergeni	Questo programma è destinato al bucato di tutti i giorni, come il cotone e le fibre sintetiche. Il vapore penetra in profondità nelle fibre, eliminando efficacemente batteri e microbi, prevenendo gli odori e proteggendo la salute.
	Vapore	Risciacquo extra con centrifuga
	Risciacquo & Centrifuga	Centrifuga extra con velocità selezionabile.
	Solo centrifuga	Lavaggio degli indumenti sportivi.
	Indumenti sportivi	Preimpostato su 20 °C. Possibilità di selezionare l'acqua fredda
	20°C	Programma speciale per i jeans.
	Jeans	Preimpostato su 40 °C. Non modificabile. Adatto per lavare articoli a circa 40 °C - 60 °C.
	ECO 40-60°C	Per migliori risultati, la durata di lavaggio è più lunga.
	Intensivo	Tessuti compatti e resistenti al calore in cotone o lino.
	Cotone	

Opzioni

Ciclo	Temp. di default (°C)	Velocità di centrifuga per default in giri/min	Funzioni supplementari
Cicli di lavaggio		1.400	
 Sintetici	40	1.200	    
 Tessuti misti	40	800	    
 Rapido 45'	40	800	   
 Rapido 15'	A freddo	800	
 Lana	40	800	  
 Anti-allergeni	60	800	    
 Vapore	40	800	    
 Risciacquo & Centrifuga	-	800	  
 Solo centrifuga	-	800	 
 Indumenti sportivi	20	800	   
 20°C	20 °C	800	  
 Jeans	30	800	   
 ECO 40-60°C	ECO 40-60	1.400	
 Intensivo	40	800	
 Cotone	40	1.400	    

NOTA

- Per maggiori informazioni sulla velocità massima di centrifuga, la durata dei programmi e maggiori dettagli sul programma ECO 40-60, si prega di consultare la pagina Scheda prodotto.
- La tabella indica le opzioni disponibili per ogni ciclo.

Temp.

Temp.

Se necessario, è possibile premere questo tasto per impostare la temperatura di lavaggio nel seguente ordine: a freddo 20 °C - 30 °C - 40 °C - 60 °C - 90 °C -

Delay

Avvio ritardato

Impostazione della funzione di avvio ritardato:

- 1 Selezionare un programma;
- 2 Premere il tasto di avvio ritardato per selezionare la durata (la durata dell'avvio ritardato è compresa tra 0 e 24 ore);
- 3 Premere il tasto "Avvio/Pausa" per attivare l'avvio ritardato.



Scegliere il programma



Impostare la durata



Avviare il programma

Cancellazione della funzione di avvio ritardato:

Premere il tasto Delay finché non compare "0h". È necessario premerlo prima di iniziare il programma. Se il programma è già avviato, è necessario arrestarlo per impostarne uno nuovo.

Soil

Sporco

La durata del lavaggio aumenta o diminuisce se si seleziona questo tasto.

**Prelavaggio**

La funzione di prelavaggio permette di effettuare un lavaggio extra prima del lavaggio principale, per rimuovere la polvere presente sulla superficie dei vestiti. Una volta selezionata questa funzione, sarà necessario aggiungere il detersivo nello scomparto (I).

**Lavaggio extra**

Questa funzione è adatta a indumenti molto sporchi. Se si seleziona questa funzione, la durata e l'intensità di lavaggio saranno aumentate per potenziare l'efficacia del lavaggio.

**Lavaggio rapido**

Questa funzione consente di ridurre la durata del lavaggio.

**Risciacquo extra**

Se si seleziona questa funzione, il bucato viene sottoposto a un risciacquo supplementare.

**Ciclo personalizzato**

Consente di memorizzare il programma utilizzato più di frequente.

Dopo aver selezionato il programma e impostato le opzioni, premere il tasto Temp. per 3 secondi prima di iniziare il lavaggio. Il programma preimpostato è il programma Cotone.

**Anti-sgualcitura**

Questa funzione permette di ottenere capi meno sgualciti.

**Aggiunta di carico**

Questa operazione può essere effettuata durante il lavaggio. Mentre il cestello sta ancora girando e vi sono ancora molta acqua e una temperatura elevata nel cestello, non è possibile forzare l'apertura dello sportello, poiché è pericoloso.

Premere il tasto "Avvio/Pausa" per 3 secondi per utilizzare questa funzione e aggiungere altri articoli durante il ciclo. Si prega di seguire le fasi indicate di seguito:

- 1 Aspettare che il cestello abbia finito di ruotare;
- 2 Il blocco dell'oblò è disattivato;
- 3 Aggiungere gli articoli desiderati, quindi chiudere l'oblò e premere il tasto "Avvio/Pausa".



Premere il tasto Avvio/Pausa per 3 secondi.

Aggiungere gli articoli desiderati

Avviare il programma

**Protezione bambini**

Consente di evitare ai bambini di manipolare la lavatrice.

Premere i tasti Funzioni e Selezione per 3 secondi finché non si sente un segnale acustico.

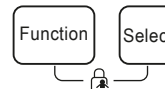

ATTENZIONE!

Quando la Protezione bambini è attivata e il programma viene avviato, la spia corrispondente a questa funzione si accende. La scritta "CL" (Protezione bambini) e la durata rimanente saranno visualizzati alternativamente ogni 0,5 secondi.

Se si premono gli altri tasti, la spia Protezione bambini lampeggerà per 3 secondi. Alla fine del programma, «CL» e «END» saranno visualizzati alternativamente per 10 secondi; quindi la spia Protezione bambini lampeggerà per 3 secondi.

- Per disattivare la Protezione bambini, è sufficiente tenere premuti entrambi i tasti, anche in caso di interruzione della corrente elettrica, quando l'apparecchio è spento e il programma è terminato.
- La funzione Protezione bambini bloccherà tutti i tasti, tranne il tasto di accensione e il tasto Protezione bambini.
- Si prega di disattivare la Protezione bambini prima di selezionare e avviare un programma.

Temp.

Temp.

Premere questo tasto per impostare la temperatura (a freddo, 20 °C, 30 °C, 40 °C, 60 °C, 90 °C).

Function

Selezionare le opzioni

Consente di selezionare le funzioni Pre Wash, Extra Rinse, Extra Wash, Night Wash e Anti-crease.

Select

Confermare le opzioni

Consente di selezionare le funzioni Pre Wash, Extra Rinse, Speed Wash, Night Wash e Anti-crease.

Speed

Velocità

Premere questo tasto per modificare la velocità.
1.400: 0 - 400 - 800 - 1.200 - 1.400

Pulizia e manutenzione**AVVERTENZA!**

Scollegare sempre l'apparecchio dalla corrente elettrica e chiudere il rubinetto dell'acqua prima di qualsiasi operazione di pulizia e manutenzione.

Pulizia del telaio dell'apparecchio

Una manutenzione adeguata della lavatrice ne prolunga il ciclo di vita. Le superfici possono essere pulite con detergenti diluiti, non abrasivi e neutri, se necessario. In caso di fuoriuscita, usare un panno per assorbire immediatamente l'acqua. Non utilizzare mai oggetti appuntiti per pulire l'apparecchio.

**ATTENZIONE!**

Non utilizzare mai prodotti caustici, acido formico o i suoi solventi diluiti o sostanze simili come alcol o prodotti chimici.

Pulizia del cestello

Qualsiasi macchia di ruggine lasciata all'interno del cestello da oggetti metallici deve essere rimossa immediatamente, mediante detergenti senza cloro. Non utilizzare mai una paglietta d'acciaio per pulire il cestello.

NOTA

Rimuovere il bucato dalla lavatrice durante la pulizia del cestello.

Pulizia della guarnizione e del vetro dell'oblò

Pulire il vetro e la guarnizione dopo ogni lavaggio per rimuovere la lanugine e le macchie. Un accumulo di lanugine può causare perdite. Rimuovere eventuali bottoni, monete e altri oggetti dalla guarnizione dopo ogni lavaggio.

Pulire la guarnizione e il vetro dell'oblò ogni mese per garantire il corretto funzionamento dell'apparecchio.

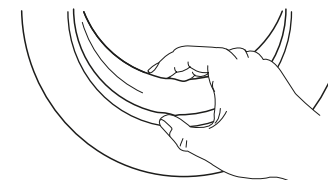

Pulizia del filtro d'ingresso**NOTA**

Un'eventuale diminuzione del flusso d'acqua indica che il filtro deve essere pulito.

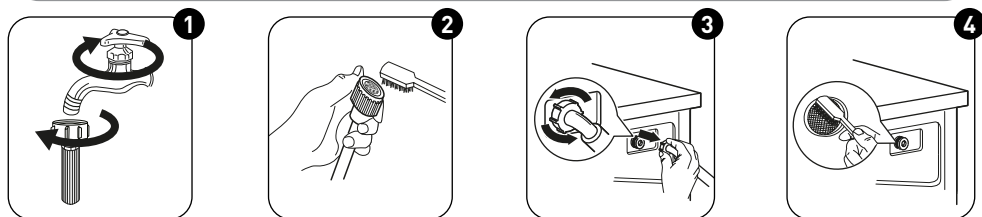

- ❶ Chiudere il rubinetto e rimuovere il tubo di ingresso dell'acqua.
- ❷ Pulire il filtro con una spazzola.
- ❸ Svitare il tubo di ingresso dell'acqua dal retro della macchina. Estrarre il filtro mediante una pinza ad ago.
- ❹ Utilizzare una spazzola per pulire il filtro.
- ❺ Reinstallare il filtro sull'ingresso dell'acqua e ricollegare il tubo di ingresso dell'acqua.
- ❻ Pulire il filtro d'ingresso ogni 3 mesi per garantire il corretto funzionamento dell'apparecchio.

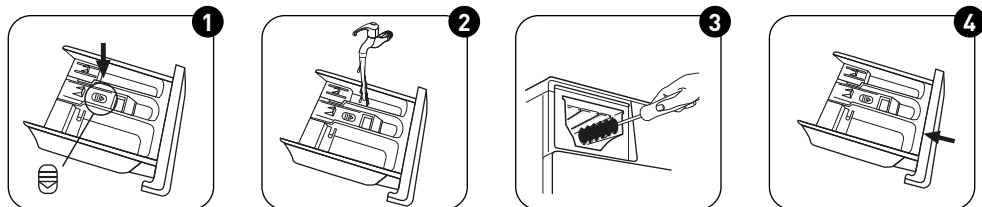
Pulizia dello scomparto dei detersivi

- ❶ Premere il tasto di sblocco e rimuovere lo scomparto.
- ❷ Lavare lo scomparto dei detersivi e il coperchio dell'ammorbidente con acqua corrente.
- ❸ Pulire il vano con una spazzola morbida.
- ❹ Reinserire lo scomparto.

NOTA

- Non utilizzare prodotti abrasivi o corrosivi per pulire le parti in plastica.
- Pulire lo scomparto dei detersivi ogni 3 mesi per garantire il corretto funzionamento dell'apparecchio.

Pulire il filtro della pompa di scarico**AVVERTENZA!**

- Attenzione all'acqua calda!
- Lasciare raffreddare la soluzione di detergente.
- Scollegare la lavatrice dall'alimentazione elettrica prima di pulirla, per evitare scosse elettriche.
- Il filtro della pompa di scarico filtra i fili e i piccoli corpi estranei derivanti dal lavaggio.
- Pulire periodicamente il filtro per garantire un funzionamento ottimale della lavatrice.

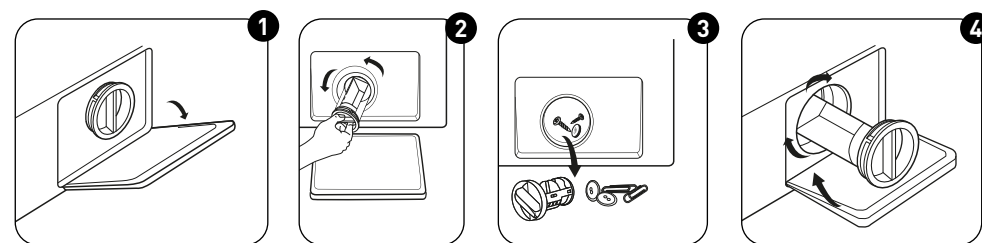

- ❶ Aprire il coperchio inferiore;
- ❷ Aprire il filtro ruotando in senso antiorario;
- ❸ Rimuovere i corpi estranei;
- ❹ Chiudere il coperchio inferiore.

ATTENZIONE!

- Assicuratevi che il tappo della valvola e il tubo di scarico di emergenza siano montati correttamente; le placche di copertura devono essere inserite allineandole con le placche forate, altrimenti potrebbero verificarsi delle perdite.
- Alcuni apparecchi non sono dotati di un tubo di scarico di emergenza; pertanto i passaggi 2 e 3 possono essere ignorati. Ruotare direttamente il coperchio inferiore per scaricare l'acqua in una bacinella.
- Quando la lavatrice è in funzione e a seconda del programma selezionato, la pompa può contenere acqua calda. Non rimuovere mai il coperchio della pompa durante un ciclo di lavaggio: attendere sempre che la lavatrice abbia completato il suo ciclo e sia vuota. Quando si sostituisce il coperchio, assicurarsi di stringerlo bene.

Risoluzione dei problemi

In caso di problemi con l'apparecchio, tentare di risolverlo mediante le tabelle qui sotto. Se il problema persiste, si prega di contattare il Servizio clienti.

Descrizione	Cause potenziali	Soluzioni
La lavatrice non si avvia	L'oblò non è chiuso correttamente. Alcuni articoli sono incastrati.	Chiudere correttamente l'oblò e riavviare l'apparecchio. Controllare il carico.
L'oblò non si apre	La protezione di sicurezza è attivata.	Scollegare l'apparecchio dalla corrente elettrica e riavviarlo.
Fuoriuscita d'acqua	I collegamenti non sono serrati a sufficienza.	Verificare e fissare il tubo d'ingresso dell'acqua. Verificare e pulire il tubo di scarico.
Presenza di residui di detersivo nello scomparto dei detersivi	Il detersivo è umido e/o coagulato.	Pulire e asciugare lo scomparto dei detersivi.
Le spie luminose o il display non funzionano	La scheda a circuito stampato o il cablaggio presentano problemi di connessione.	Spegnere l'alimentazione elettrica e controllare che la spina sia collegata correttamente.
Rumori anomali	I bulloni di protezione per il trasporto non sono stati rimossi. Il pavimento non è solido né orizzontale.	Verificare che i bulloni di protezione per il trasporto siano stati rimossi. Assicurarsi che l'apparecchio sia installato su una superficie piana e solida.

Codici di errore

Descrizione	Cause potenziali	Soluzioni
E30	L'oblò non è chiuso correttamente.	Chiudere correttamente l'oblò e riavviare l'apparecchio.
E10	Problema di iniezione d'acqua durante il ciclo di lavaggio	Verificare se la pressione dell'acqua è sufficiente. Raddrizzare il tubo dell'acqua. Pulire il filtro della valvola di alimentazione.
E21	Scarico dell'acqua troppo lungo	Verificare che tubo di scarico non sia ostruito.
E12	Fuoriuscita d'acqua	Riavviare l'apparecchio.
EXX	Altro	Riavviare l'apparecchio. Se il problema persiste, si prega di contattare il Servizio clienti.

Servizio clienti

I pezzi di ricambio saranno disponibili per il vostro apparecchio per almeno 10 anni. Per eventuali domande, si prega di contattare il nostro Servizio clienti:

AVVERTENZA!

Rischio di scossa elettrica

- Non tentare mai di riparare un apparecchio difettoso o che si presume tale. Potreste mettere in pericolo la vostra vita e quella dei futuri utenti. Soltanto tecnici autorizzati sono abilitati ad effettuare tali riparazioni.
- Riparazioni improprie fanno decadere la garanzia ed eventuali danni collaterali non saranno riconosciuti!

Trasporto

PASSAGGI IMPORTANTI DA SEGUIRE PER LA MOVIMENTAZIONE DELL'APPARECCHIO

- Scollegare l'apparecchio dall'alimentazione elettrica e chiudere il rubinetto di ingresso dell'acqua
- Controllare che l'oblò e lo scomparto dei detersivi siano chiusi correttamente.
- Rimuovere il tubo di ingresso dell'acqua e il tubo di scarico dal corpo dell'apparecchio.
- Lasciare defluire tutta l'acqua dall'apparecchio (vedi "Pulizia del filtro della pompa di scarico").
- Nota importante: reinstallare i 4 bulloni di trasporto sul retro dell'apparecchio.
- Questo apparecchio è pesante. Movimentarlo con precauzione. Non afferrare mai una parte sporgente dell'apparecchio per sollevarlo. L'oblò della lavatrice non può essere usato come maniglia.

